

OWNERS MANUAL
PREAMPLIFIERS
INTEGRATED AMPLIFIERS, POWER AMPLIFIERS
ENGLISH DEUTSCH FRANÇAIS ITALIANO

SAFETY INSTRUCTIONS

In order to comply with current European safety regulations it is essential that the Naim loudspeaker connectors supplied with amplifiers and loudspeakers are used.

Do not under any circumstances allow anyone to modify your Naim equipment without first checking with the factory, your retailer, or your distributor. Unauthorised modifications will invalidate your guarantee.

Equipment must not be exposed to dripping or splashing and no objects filled with liquid, such as vases, should be placed on the equipment.

For your own safety do not under any circumstances open Naim equipment without first disconnecting it from the mains.

Warning: an apparatus with CLASS I construction shall be connected to a mains socket outlet with a protective earthing connection.

Where the mains plug or an appliance coupler is used as the disconnect device, the disconnect device shall remain readily operable. To disconnect the equipment from the mains remove the mains plug from the mains outlet.

The following label is attached to all mains powered equipment:



NOTE

This equipment has been tested and found to comply with the relevant EMC and Safety Standards, and, where applicable, also complies with the limits for a class B digital device, pursuant to Part 15 of the FCC Rules.

These limits are designed to provide reasonable protection against harmful interference in a residential installation. This equipment generates, uses and can radiate radio frequency and, if not installed and used in accordance with the instructions, may cause harmful interference to radio communications. However, there is no guarantee that interference will not occur in a particular installation. If this equipment does cause harmful interference to radio or television reception, which can be determined by turning off and on, the user is encouraged to try to correct the interference by one or more of the following measures:

- Reorient or relocate the receiving antenna.
- Increase the separation between the equipment and the receiver.
- Connect the equipment into an outlet on a circuit different from that to which the receiver is connected.
- Consult your Naim retailer or an experienced radio/TV technician for help.

Contents

Page	Section
E1	1 Connections
E1	2 Mains Power
E2	3 General Installation
E3	4 NAC 552 Introduction and Installation
E4	5 NAC 552 Controls and Connections
E5	6 NAC 552 Specification
E6	7 NAC 252 Introduction and Installation
E6	8 NAC 252 Controls and Connections
E7	9 NAC 252 Specification
E8	10 NAC 282 Introduction and Installation
E8	11 NAC 282 Controls and Connections
E10	12 NAC 282 Specification
E11	13 NAC 202 Introduction and Installation
E11	14 NAC 202 Controls and Connections
E12	15 NAC 202 Specification
E13	16 NAC 152 XS Introduction and Installation
E14	17 NAC 152 XS Controls and Connections
E16	18 NAC 152 XS Specification
E17	19 Supernait Introduction and Installation
E19	20 Supernait Controls and Connections
E21	21 Supernait Specification
E22	22 Nait XS Introduction and Installation
E23	23 Nait XS Controls and Connections
E25	24 Nait XS Specification
E26	25 Nait 5i Introduction and Installation
E26	26 Nait 5i Controls and Connections
E27	27 Nait 5i Specification
E28	28 Preamplifier and Integrated Amplifier Operation
E31	29 R-com Remote Handset
E32	30 NARCOM 4 Remote Handset
E33	31 NAP 500 Installation and Operation
E34	32 NAP 500 Connections
E34	33 NAP 500 Specification
E35	34 NAP 300 Installation and Operation
E36	35 NAP 300 Connections
E36	36 NAP 300 Specification
E37	37 NAP 250 Installation and Operation
E37	38 NAP 250 Connections
E37	39 NAP 250 Specification
E38	40 NAPV 145 Installation and Operation
E38	41 NAPV 145 Connections
E38	42 NAPV 145 Specification
E39	43 NAP 200 Installation and Operation
E39	44 NAP 200 Connections
E39	45 NAP 200 Specification
E40	46 NAP 155 XS Installation and Operation
E40	47 NAP 155 XS Connections
E40	48 NAP 155 XS Specification
E41	49 NAPV 175 Installation and Operation
E41	50 NAPV 175 Connections
E42	51 NAPV 175 Specification
E42	52 Declarations of Conformity

Introduction

Naim Audio products are conceived with performance as the top priority. Careful installation will help ensure that their full potential is achieved. This manual covers all preamplifiers, integrated amplifiers and power amplifiers. It begins with some general installation notes and statutory safety warnings. Product specific information begins in Section 4.

1 Connections

It is important for both safety and performance that the standard cables supplied are not modified.

1.1 Interconnect Cables

If options are available with your equipment and installation, DIN interconnect sockets should be used in preference to RCA Phono sockets. One end of each Naim interconnect cable is marked with a band to establish its correct orientation. The band denotes the end that connects to the signal source.

Interconnect plugs and sockets should be kept clean and free from corrosion. The easiest way to clean them is to switch off the equipment, pull the plugs out of their sockets, and push them back in again. Contact cleaners and “enhancers” should not be used as the film they deposit may degrade the sound.

1.2 Loudspeaker Cables

Loudspeaker cables are vitally important. They should each be at least 3.5 metres long and of equal length. The recommended maximum is normally 20 metres although longer cables may be viable with some Naim amplifiers.

Some Naim amplifiers are designed only to work with Naim loudspeaker cable and using alternatives may degrade the performance or even damage the amplifier. Other Naim amplifiers can be used with any high quality loudspeaker cable although we recommend that Naim loudspeaker cable is used. Naim loudspeaker cable is directional and should be oriented so that the printed arrow points towards the speakers. The Naim loudspeaker connectors supplied are designed to comply with European safety legislation and must be used.

Contact your local retailer or distributor for further advice on loudspeaker cables and connectors.

2 Mains Power

Where fused plugs are used 13 amp fuses should be fitted. Fuses of a lower rating will fail after a period of use. Do not wire voltage dependent resistors or noise suppressors into mains plugs. They degrade the mains supply and the sound.

2.1 Mains Plug Wiring

In some territories a mains plug may need to be fitted to the supplied mains lead. As the colours of the wires in

the mains lead may not correspond with the coloured markings identifying the terminals in the plug proceed as follows:

The wire coloured **GREEN-AND-YELLOW** must be connected to the terminal in the plug marked by the letter **E** or by the safety earth symbol or coloured **GREEN** or **GREEN** and **YELLOW**.

The wire coloured **BLUE** must be connected to the terminal in the plug marked with the letter **N** or coloured **BLACK**.

The wire coloured **BROWN** must be connected to the terminal in the plug marked with the letter **L** or coloured **RED**.

2.2 Equipment Fuses

Mains powered Naim Audio equipment is fitted with a mains fuse on the rear panel adjacent to the mains input socket. Replace it if necessary only with the spare fuse supplied or with an identical fuse. Repeated failure of the fuse points to a fault that should be investigated by your retailer or Naim itself.

2.3 Non-rewirable Mains Plugs

If a non-rewirable plug is cut from a mains lead (for whatever purpose) the plug **MUST** be disposed of in a way to render it totally useless. Considerable shock hazard exists if the cut-off plug is inserted into a mains outlet.

2.4 Mains Circuits and Cables

A hi-fi system usually shares a mains circuit with other household equipment some of which can cause distortion of the mains waveform. This distortion can in turn lead to mechanical hum from mains transformers. Some Naim transformers are large in size, making them relatively sensitive to such distortion, and it may be necessary to take account of transformer hum when siting your equipment.

Transformer hum is not transmitted through the speakers and has no effect on the performance of the system; however, a separate mains circuit may reduce it. Such a circuit (ideally with a 30 or 45 Amp rating) will also generally improve system performance. Advice on the installation of a separate mains circuit should be sought from a qualified electrician.

Do not substitute alternative mains leads and plugs to those supplied. They are selected to offer the best possible performance.

Introduction

3 General Installation

Naim equipment is designed to offer the finest performance possible avoiding compromise wherever practical. This can lead to circumstances that may be unfamiliar. The notes that follow contain advice specifically related to Naim equipment as well as more general warnings about the use of domestic audio products. Please read them carefully.

3.1 Siting The Equipment

In order to reduce the risk of hum audible from the loudspeakers, power supplies and power amplifiers should be located a reasonable distance away from other equipment. The maximum separation distance for connected equipment is that allowed by the standard interconnect lead.

Some Naim equipment is extremely heavy. Check the weight of the equipment prior to lifting and if necessary use more than one person so that it can be moved safely. Ensure that your equipment rack or table can easily support the weight and is stable.

Some speakers and stands are intended to be used with floor spikes fitted. Care should be taken when siting and moving them to avoid personal injury or damage to cables and surfaces. Floor protectors are available from your local dealer or distributor to protect non carpeted floors.

3.2 Switching On

Source components and power supplies should be switched on before the power amplifiers. Always switch amplifiers off and wait a minute before connecting or disconnecting any leads. Always use the power switch on the product rather than a mains outlet switch.

A "thump" may be heard from the loudspeakers as power amplifiers are switched on. This is normal, will not cause any loudspeaker damage and does not point to any fault or problem. A mild "pop" may also be heard shortly after equipment is switched off.

3.3 Running In

Naim equipment takes a considerable time to run in before it performs at its best. The duration varies, but under some conditions the sound may continue to improve for over a month. Better and more consistent performance will be achieved if the system is left switched on for long periods. It is worth remembering however that equipment left connected to the mains can be damaged by lightning.

3.4 Radio Interference

In some circumstances, depending on where you live and the earthing arrangements in your home, you may experience radio frequency interference. Controls on broadcasting in some territories allow very high levels of radio frequency radiation and both the choice and exact siting of equipment may be critical. Susceptibility to radio frequency interference is related to the wide internal bandwidth necessary for high sound quality. A radio frequency filter kit is available for some Naim equipment but sound quality will be progressively compromised as more elements of the kit are fitted.

3.5 Lightning Precautions

Your Naim hi-fi system can be damaged by lightning and should be turned off and disconnected from the mains when there is risk of lightning strike. For complete protection all mains plugs and any aerial cables should be disconnected when not in use.

3.6 Problems?

Consumer protection varies from country to country. In most territories a retailer must be prepared to take back any equipment he has sold if it cannot be made to work satisfactorily. A problem may be due to a fault in the system or its installation so it is essential to make full use of your dealer's diagnostic skills. Please contact your local distributor, or Naim Audio directly, if any difficulties cannot be resolved.

Some Naim equipment is made in special versions for different territories and this makes it impracticable to arrange international guarantees. Please establish the local guarantee arrangements with your retailer. Contact Naim Audio directly for help and advice if necessary.

3.7 Service and Updates

It is essential that repairs and updates are only carried out by an authorised Naim retailer or at the factory by Naim itself. Many components are custom made, tested or matched and appropriate replacements are often unobtainable from other sources.

Direct contact to Naim for service or update information should be made initially through Customer Services:

Tel: **+44 (0)1722 426600**
Email: **info@naimaudio.com**

Please quote the product serial number (found on its rear panel) in all correspondence.

NAC 552 Preamplifier

4 NAC 552 Introduction and Installation

The NAC 552 preamplifier does not incorporate an internal power supply and can be used only in conjunction with the NAC 552PS power supply. Diagram 5.3 illustrates connection of the NAC 552 to its power supply.

The four transit screws on the underside of the NAC 552 case should be removed before use and must be replaced if the unit is to be re-packed and shipped. These transit screws must not be used in any other Naim product. Do not invert the NAC 552 once the transit screws are removed.

The preamplifier and power supply should be installed on a dedicated equipment stand intended for the purpose. Do not stand either directly on top of another item of equipment. Care should be taken to ensure that the preamplifier is level.

The preamplifier and power supply should be installed in their final locations before connecting cables or switching on. Ensure that power amplifiers are switched off and that the preamplifier volume is turned down before the power supply is switched on. The power button is located on the power supply front panel.

The units are heavy and care should be taken when lifting or moving them. Make sure that the surface on which they are to be placed can support their weight.

The following Section 4 paragraphs describe installation features and functions specific to the NAC 552. Operational features common to all preamplifiers and integrated amplifiers are described in Section 28.

Both R-Com and NARCOM 4 remote handsets are included with the NAC 552. The R-com is intended for day-to-day use while the NARCOM 4 can be used for handset-based setup and programming.

4.1 Source Inputs and Record Outputs

The input selection buttons arranged along the upper bank select the source signal to be routed to the power amplifier and the loudspeakers. Below them, in the lower bank, is a corresponding array of buttons which select the signal to be routed to the preamplifier's record outputs.

These separate source and record sections enable one source (a CD player, for example) to be listened to whilst the output from another (say, the tuner) is simultaneously selected for recording.

Note: *It is possible to lock the record controls and prevent accidental de-selection during recording. Record-lock is switched on or off by pressing the source mono button four times within six seconds.*

Indicators are fitted to the NAC 552 rear panel above each input socket. These indicators illuminate to provide information on input selection and on input mapping setup and programming.

4.2 Input Socket Assignment

Any NAC 552 source input socket can be selected by any button. For example, while the NAC 552 default setup is for the CD input button to select input socket No. 2, custom programming of input assignment could enable any input socket to be selected by pressing the CD button. Assigning of each record button follows the corresponding source button.

Operational features common to all preamplifiers and integrated amplifiers are described in Section 28

Input assignment setup is accessed through the NAC 552 **program mode**. To switch into (or exit from) program mode press and hold the **prog** key on the remote handset (in preamplifier mode). Program mode is indicated by a flashing indicator on the front panel volume control and the record selection indicators extinguishing.

Note: *If no function is operated within five minutes of entering program mode the NAC 552 will return to normal mode automatically.*

Any of the six source buttons on the front panel can be assigned to any of the nine stereo inputs (seven DIN sockets and two RCA Phono socket pairs) on the rear panel. In program mode, as a source input is selected, a rear panel indicator will illuminate to designate the socket to which it is assigned.

To change the input socket assigned to a source button, select the **source** button and use the front panel record **mute** and **mono** buttons to scroll along the input sockets. If the input socket selected is already assigned to a source button the indicator above the socket will flash repeatedly. It is possible to assign one input socket to more than one source button but NOT to assign multiple input sockets to one source button. The remote handset **record mute** and **mono** functions can also be used to set up input assignment.

NAC 552 Preamplifier

To exit from program mode press and hold the **prog** key on the handset until the record select indicators are restored and the volume indicator stops flashing.

Table 4.3 illustrates the NAC 552 default input assignment.

4.3 Socket Types and Assignment Defaults

Input Socket Number	Socket Features	Source Button Assignment Default
1	DIN input	Not assigned
2	DIN input	CD
3	DIN input	TUNER
4	DIN input/output, unity gain capable	TAPE
5	DIN input/output, unity gain capable	AV
6	DIN input/output	AUX 1
7	DIN input, power output for phono stage	AUX 2
8	RCA Phono pair	Not assigned
9	RCA Phono pair	Not assigned

5 NAC 552 Controls and Connections

5.1 NAC 552 Front

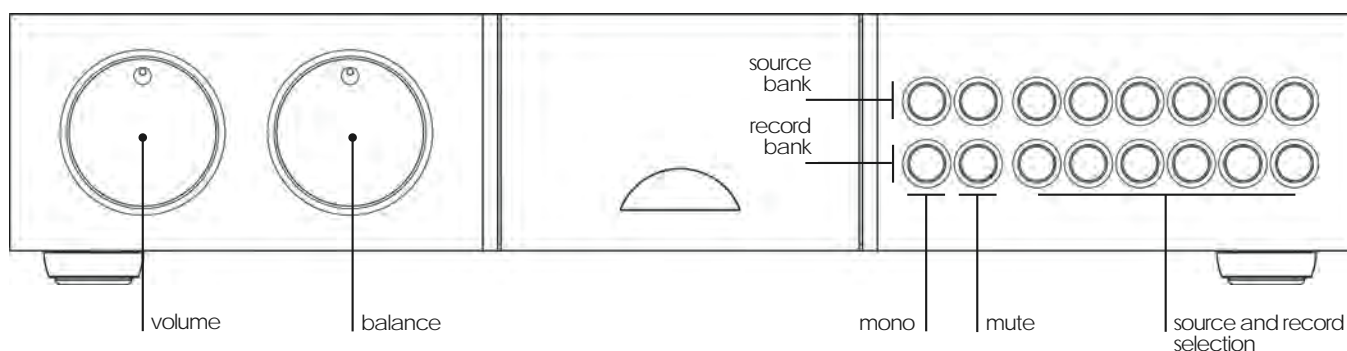

5.2 NAC 552 Rear

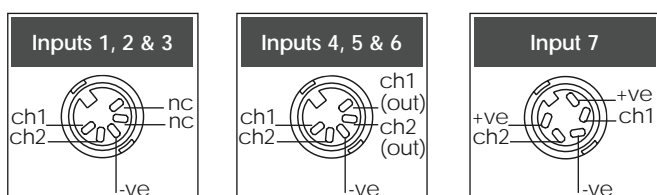
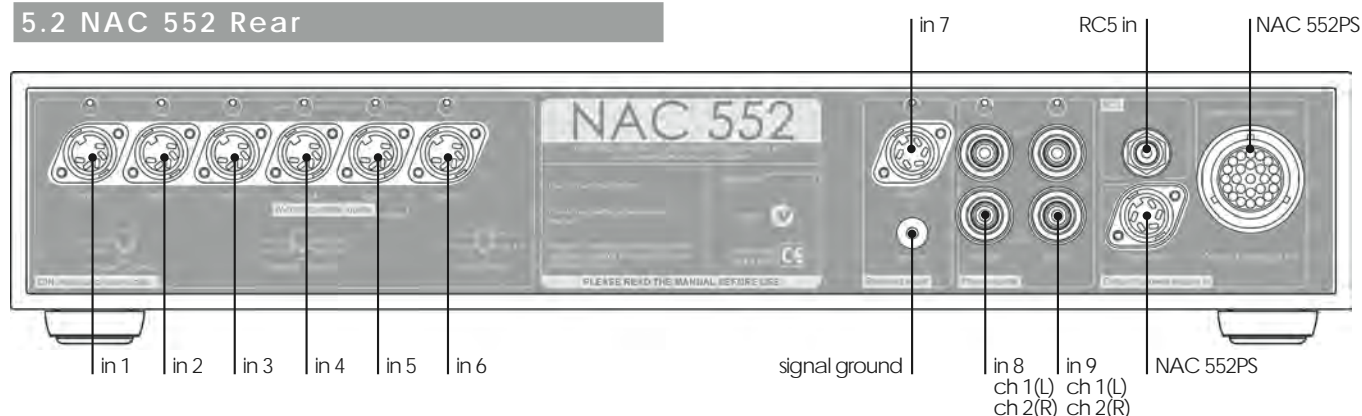

NAC 552 Preamplifier

5.3 NAC 552 Connected to NAC 552PS

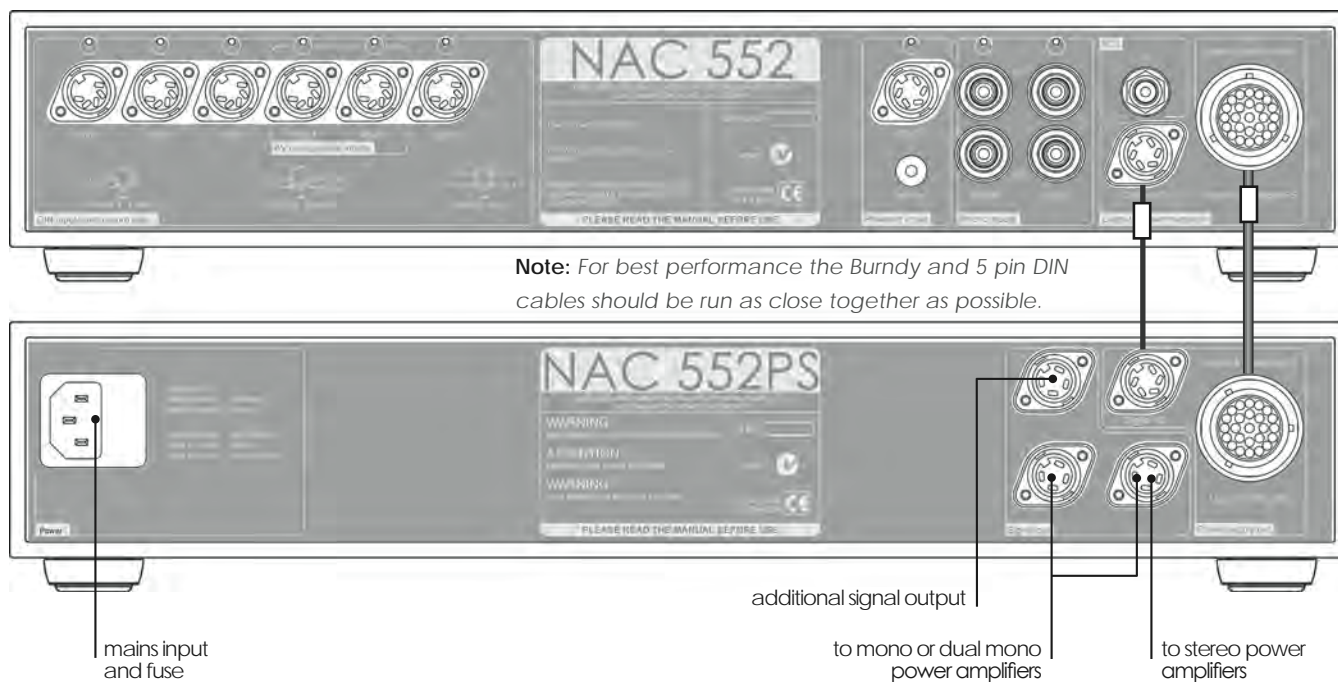

6 NAC 552/NAC 552PS Specification

Input Sensitivities:	75mV, 47k Ω
Overload Margins:	40dB (all inputs all audio frequencies).
Main Output Level:	0.775V, <50 Ω
Tape Output Level:	75mV, 600 Ω
Auxiliary Power Outputs:	For Naim phono stage
Dimensions (H x W x D):	Both 87 x 432 x 314mm
Weight:	NAC 552 - 12.9kg NAC 552PS - 13.9kg
Mains Supply (NAC 552PS):	100-120V or 220-240V, 50/60Hz

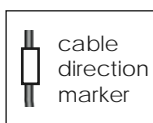

Interconnect Cables

NAC 552 Burndy	
240° 5 to 5 pin DIN	

NAC 252 Preamplifier

7 NAC 252 Introduction and Installation

The NAC 252 preamplifier does not incorporate an internal power supply and can be used only in conjunction with the Supercap power supply. Diagram 8.3 illustrates connection of the NAC 252 to its power supply.

The preamplifier and power supply should be installed on a dedicated equipment stand intended for the purpose. Do not stand either directly on top of another item of equipment. Care should be taken to ensure that the preamplifier is level.

The preamplifier and power supply should be installed in their final locations before connecting cables or switching on. Ensure that power amplifiers are switched off and the preamplifier volume is turned down before the power supply is switched on. The power button is located on the power supply front panel.

The power supply is heavy and care should be taken when lifting or moving it. Make sure that the surface on which it is to be placed can support its weight.

The following Section 7 paragraphs describe installation features and functions specific to the NAC 252. Operational features common to all preamplifiers and integrated amplifiers are described in Section 28.

Operational features common to all preamplifiers and integrated amplifiers are described in Section 28

7.1 Source Inputs and Record Outputs

The input selection buttons arranged along the upper bank select the source signal to be routed to the power amplifier and the loudspeakers. Below them, in the lower bank, are a corresponding array of buttons which select the signal to be routed to the preamplifier's record outputs.

These separate source and record sections enable one source (a CD player, for example) to be listened to whilst the output from another (say, the tuner) is simultaneously selected for recording.

Note: It is possible to lock the record controls and prevent accidental de-selection during recording. Record-lock is switched on or off by pressing the source mono button four times within six seconds.

7.2 Input Socket Assignment

The NAC 252 has six DIN input sockets and two alternative pairs of RCA Phono sockets. The RCA Phono sockets can be assigned individually to the CD and AUX 2 input buttons in place of the DIN sockets.

Input assignment setup is accessed through the NAC 252 program mode. To switch into (or exit from) program mode press and hold the **prog** key on the remote handset (in preamplifier mode). Program mode is indicated by a flashing indicator on the front panel volume control and the record selection indicators extinguishing.

Note: If no function is operated within five minutes of entering program mode the NAC 252 will return to normal mode automatically.

Once in program mode press and hold the remote handset **1** key to select or de-select the RCA Phono socket input for CD, and the remote handset **6** key to select or de-select the RCA Phono socket input for AUX 2. The corresponding front panel input buttons can similarly be used to select or de-select the RCA Phono socket inputs. The appropriate input button indicator will flash three times on selection of the RCA Phono option and once on selection of the DIN option.

To exit from program mode press and hold the **prog** key on the handset until the record select indicators are restored and the volume indicator stops flashing.

8 NAC 252 Controls and Connections

8.1 NAC 252 Front

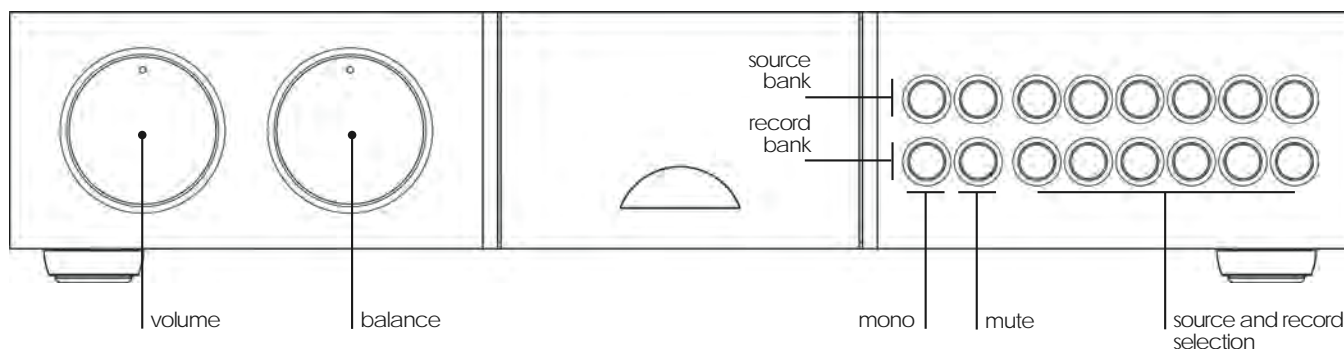

NAC 252 Preamplifier

8.2 NAC 252 Rear

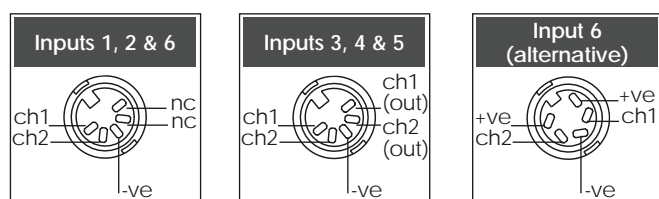
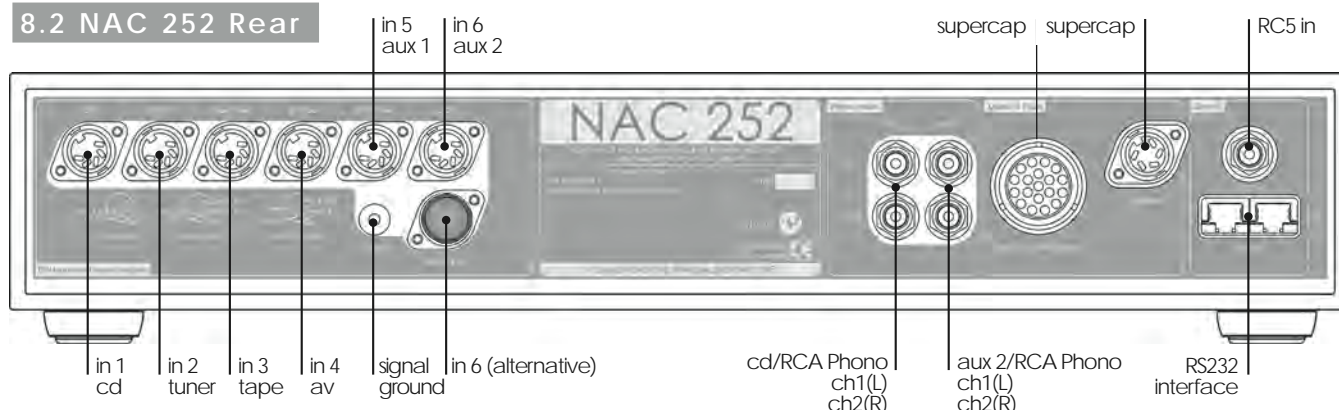

Note: The NAC 252 AUX 2 input is provided with two sockets. The lower socket, fitted on delivery with a blanking cover, is intended for use with a Naim Audio RCA Phono stage and incorporates an appropriate DC power supply. The two sockets must not be used simultaneously.

Note: The RS232/comms interface is an optional upgrade. It can be specified at time of order or fitted retrospectively. Contact your local representative or Naim Audio directly for further information.

8.3 NAC 252 Connected to Supercap

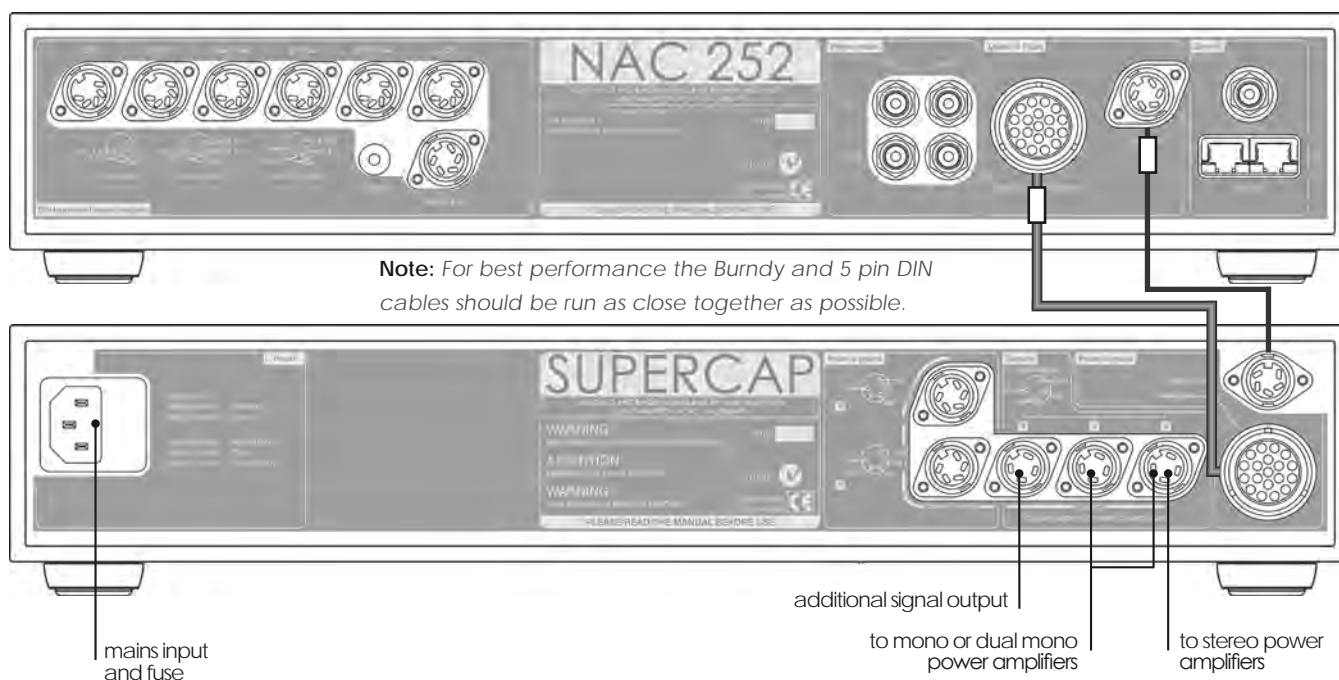

9 NAC 252/Supercap Specification

Input Sensitivities:	75mV, 47k Ω
Overload Margins:	40dB
	(all inputs all audio frequencies)
Main Output Level:	0.775V, <50 Ω
Tape Output Level:	75mV, 600 Ω
Auxiliary Power Outputs:	For Naim phono stage.
Dimensions (H x W x D):	Both 87 x 432 x 314mm
Weight:	NAC 252 - 7.0kg
	Supercap - 11.6kg
Mains Supply (Supercap):	100-120V or 220-240V, 50/60Hz

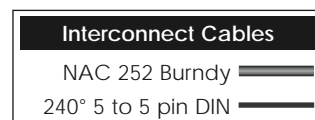
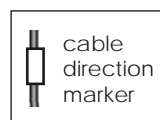

NAC 282 Preamplifier

10 NAC 282 Introduction and Installation

The NAC 282 preamplifier does not incorporate an internal power supply but must be used in conjunction with either a Naim power amplifier incorporating a preamplifier power output, or with an appropriate Naim power supply. A separate NAPSC supply that provides power to the display and control circuits is supplied. Diagrams 11.3 and 11.4 illustrate two NAC 282 power supply options.

The preamplifier and power supply should be installed on a dedicated equipment stand intended for the purpose. Do not stand either directly on top of another item of equipment. Care should be taken to ensure that the preamplifier is level.

The preamplifier and any power supply should be installed in their final locations before connecting cables or switching on. Ensure that the preamplifier volume is turned down before switching on.

The following Section 10 paragraphs describe installation features and functions specific to the NAC 282. Operational features common to all preamplifiers and integrated amplifiers are described in Section 28.

Operational features common to all preamplifiers and integrated amplifiers are described in Section 28

10.1 Source Inputs and Record Outputs

The input selection buttons arranged along the upper bank select the source signal to be routed to the power amplifier and the loudspeakers. Below them, in the lower bank, are a corresponding array of buttons which select the signal to be routed to the preamplifier's record outputs.

These separate source and record sections enable one source (a CD player, for example) to be listened to whilst the output from another (say, the tuner) is simultaneously selected for recording.

Note: It is possible to lock the record controls and prevent accidental de-selection during recording. Record-lock is switched on or off by depressing the source mono button four times within six seconds.

10.2 Input Socket Assignment

The NAC 282 has six DIN input sockets and two alternative pairs of RCA Phono sockets. The RCA Phono sockets can be assigned individually to the CD and AUX 2 input buttons in place of the DIN sockets.

Input assignment setup is accessed through the NAC 282 program mode. To switch into (or exit from) program mode press and hold the **prog** key on the remote handset (in preamplifier mode). Program mode is indicated by a flashing indicator on the front panel volume control and the record selection indicators extinguishing.

Note: If no function is operated within five minutes of entering program mode the NAC 282 will return to normal mode automatically.

Once in program mode press and hold the remote handset **1** key to select or de-select the RCA Phono socket input for CD, and the remote handset **6** key to select or de-select the RCA Phono socket input for AUX 2. The corresponding front panel input buttons can similarly be used to select or de-select the RCA Phono socket inputs. The appropriate input button indicator will flash three times on selection of the RCA Phono option and once on selection of the DIN option.

To exit from program mode press and hold the **prog** key on the handset until the record select indicators are restored and the volume indicator stops flashing.

11 NAC 282 Controls and Connections

11.1 NAC 282 Front

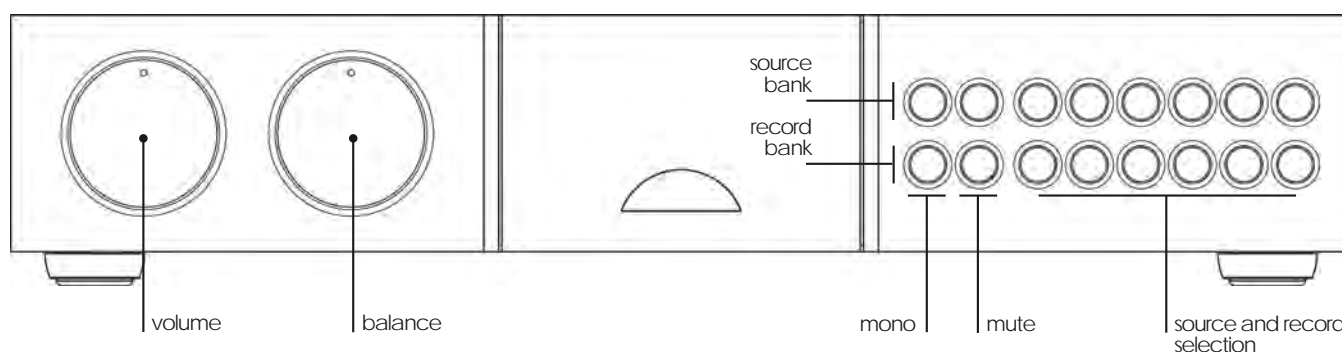

NAC 282 Preamplifier

11.2 NAC 282 Rear

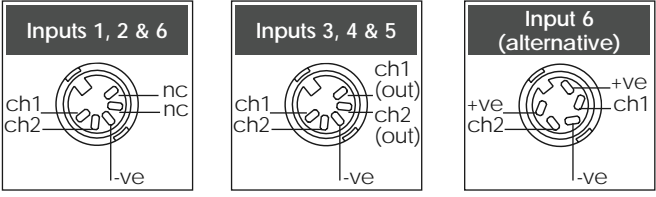
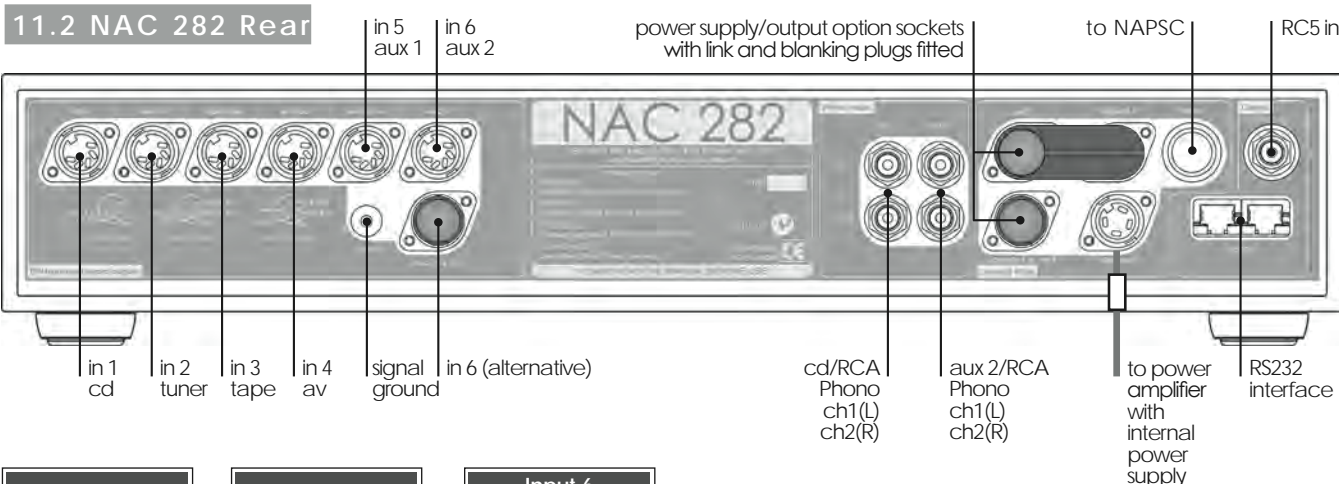

Note: The NAC 282 AUX 2 input is provided with two sockets. The lower socket, fitted on delivery with a blanking cover, is intended for use with a Stageline or Prefix Phono stage and incorporates an appropriate DC power supply. The two sockets must not be used simultaneously.

Note: The RS232/comms interface is an optional upgrade. It can be specified at time of order or fitted retrospectively. Contact your local representative or Naim Audio directly for further information.

11.3 NAC 282 Connected to Supercap and NAPSC

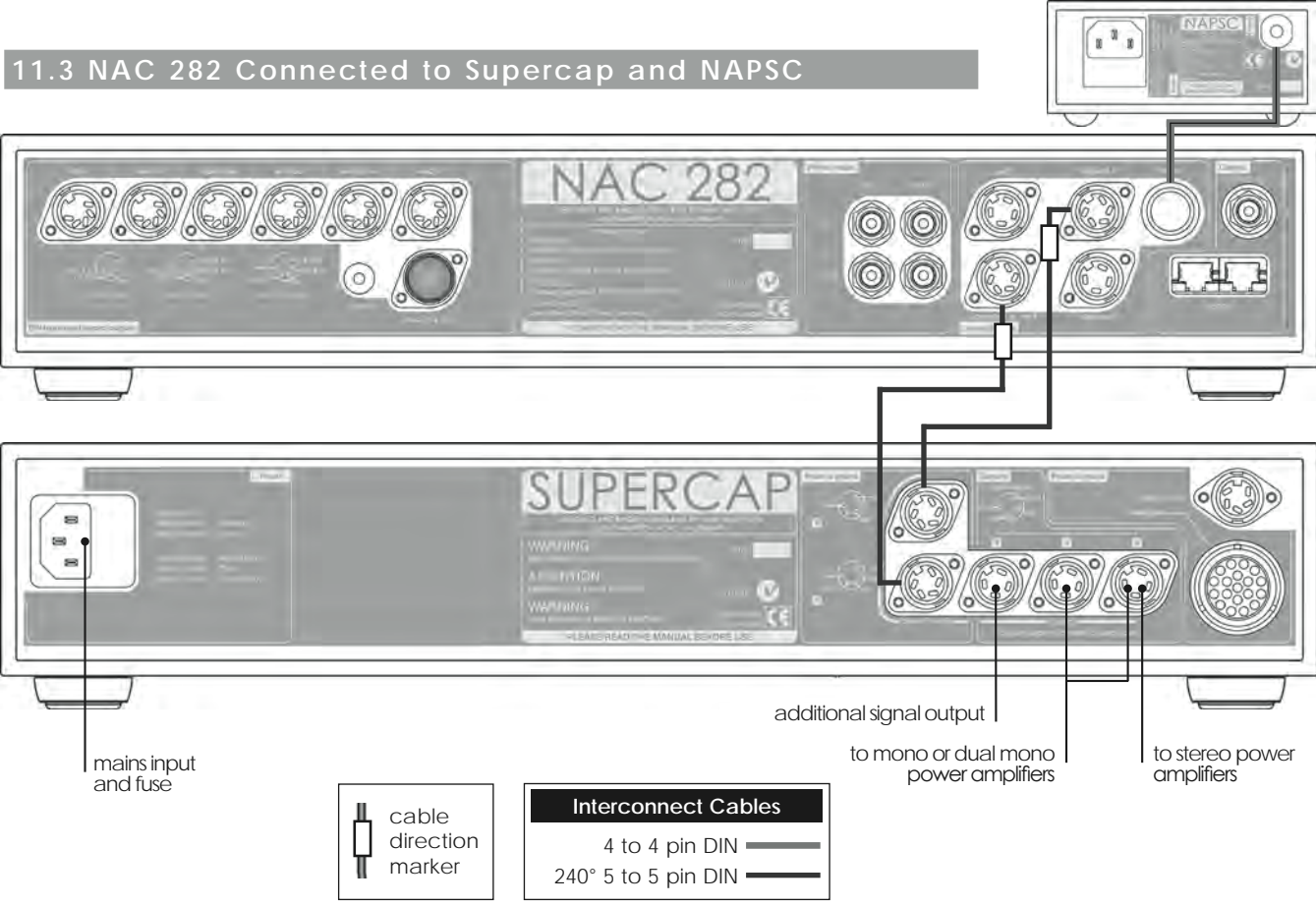

NAC 282 Preamplifier

11.4 NAC 282 Connected to Hi-Cap and NAPSC

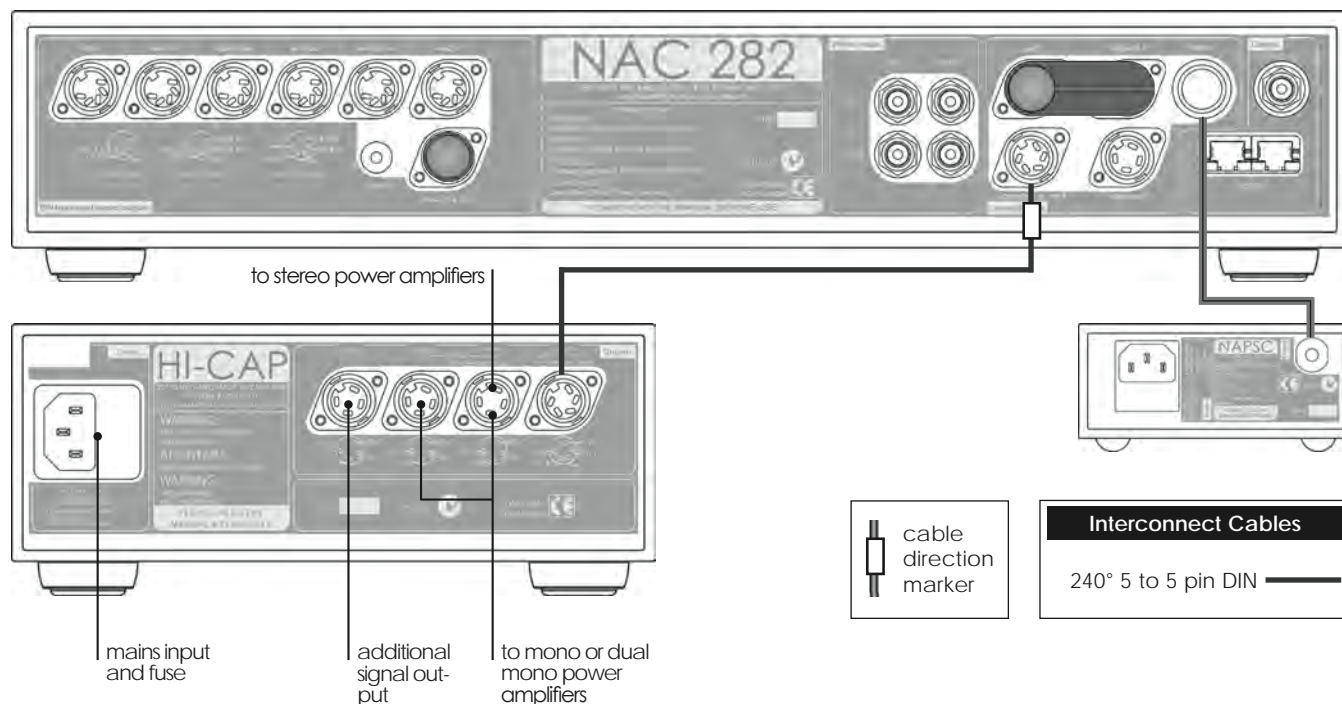

Note: Alternative upgrade schemes and product combinations may be feasible. Contact your local representative or Naim Audio directly for further information.

12 NAC 282 Specification

Input Sensitivities:	75mV, 47k Ω
Overload Margins:	40dB (all inputs all audio frequencies)
Main Output Level:	0.775V, <50 Ω
Tape Output Level:	75mV, 600 Ω
Auxiliary Power Outputs:	For Naim phono stage.
Dimensions (H x W x D):	87 x 432 x 314mm
Weight:	7.0kg

NAC 202 Preamplifier

13 NAC 202 Introduction and Installation

The NAC 202 preamplifier does not incorporate an internal power supply but must be used in conjunction with either a Naim power amplifier incorporating a preamplifier power output, or with an appropriate Naim power supply. A separate NAPSC supply that provides power to the display and control circuits is also available. Diagram 14.3 illustrates the NAC 202 connected to a Hi-Cap power supply.

The preamplifier and any power supply should be installed on a dedicated equipment stand intended for the purpose. Do not stand either directly on top of another item of equipment. Care should be taken to ensure that the preamplifier is level.

The preamplifier and any power supply should be installed in their final locations before connecting cables or switching on. Ensure that the preamplifier volume is turned down before switching on.

The following Section 13 paragraphs describe installation features and functions specific to the NAC 202. Operational features common to all preamplifiers and integrated amplifiers are described in Section 28.

Operational features common to all preamplifiers and integrated amplifiers are described in Section 28

13.1 Input Sockets and Assignment

The input selection buttons select the source input signal to be routed to the power amplifier and the loudspeakers.

The NAC 202 has six DIN input sockets and two alternative pairs of RCA Phono sockets. The RCA Phono sockets can be assigned individually to the CD and AUX 2 input buttons in place of the DIN sockets.

Input assignment setup is accessed through the NAC 202 program mode. To switch into (or exit from) program mode press and hold the **prog** key on the remote handset (in preamplifier mode). Program mode is indicated by a flashing indicator on the front panel volume control.

Note: If no function is operated within five minutes of entering program mode the NAC 202 will return to normal mode automatically.

Once in program mode press and hold the remote handset **1** button to select or de-select the RCA Phono socket input for CD, and the remote handset **6** button to

select or de-select the RCA Phono socket input for AUX 2. The corresponding front panel input buttons can similarly be used to select or de-select the RCA Phono socket inputs. The appropriate input button indicator will flash three times on selection of the RCA Phono option and once on selection of the DIN option.

To exit from program mode press and hold the **prog** key on the remote until the volume indicator stops flashing.

13.2 Record Mute

In order to minimise power consumption and improve sound quality the NAC 202 record output circuit can be muted. To engage or disengage **record mute** press the front panel **mon** button followed by the front panel **mute** button. The **mute** button indicator will illuminate when record mute is engaged and extinguish when it is disengaged. Record mute can also be engaged and disengaged from the remote handset using the **mon** and **mute** keys.

14 NAC 202 Controls and Connections

14.1 NAC 202 Front

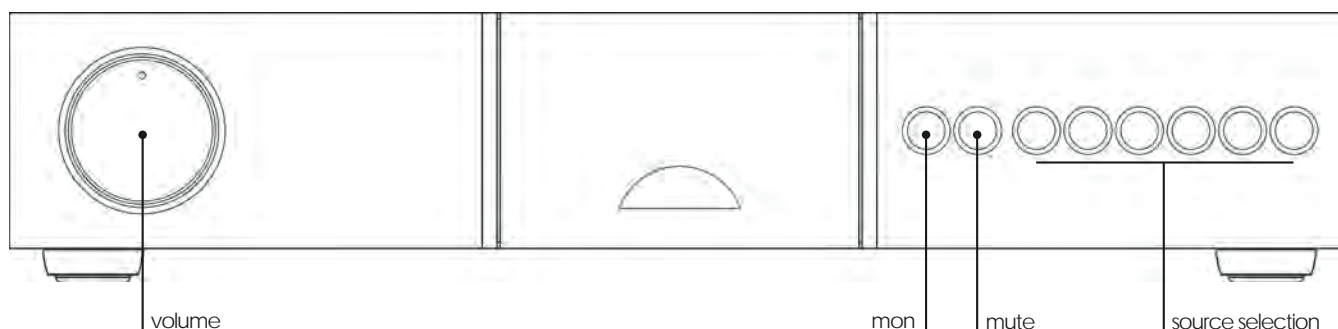

NAC 202 Preamplifier

14.2 NAC 202 Rear

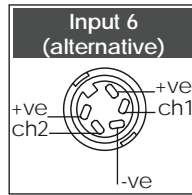
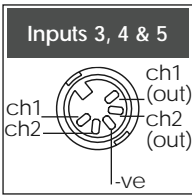
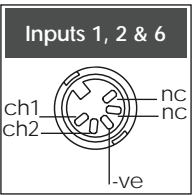
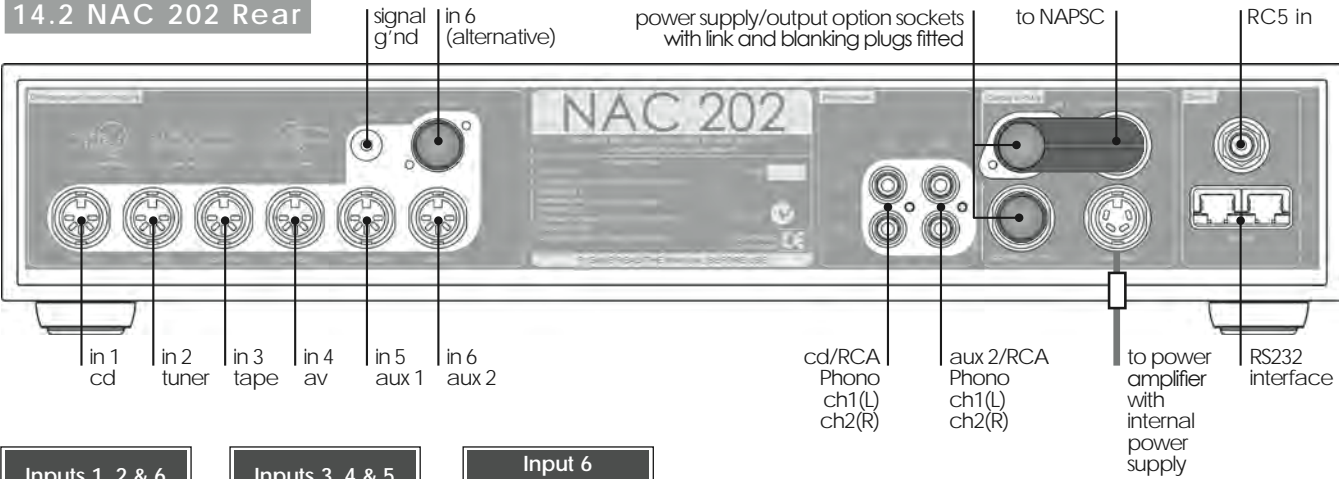

Note: The NAC 202 AUX 2 input is provided with two sockets. The upper socket, fitted on delivery with a blanking cover, is intended for use with a Stageline or Prefix Phono stage and incorporates an appropriate DC power supply. The two sockets must not be used simultaneously.

Note: The RS232/comms interface is an optional upgrade. It can be specified at time of order or fitted retrospectively. Contact your local representative or Naim Audio directly for further information.

14.3 NAC 202 Connected to Hi-Cap and NAPSC

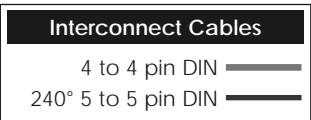
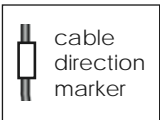
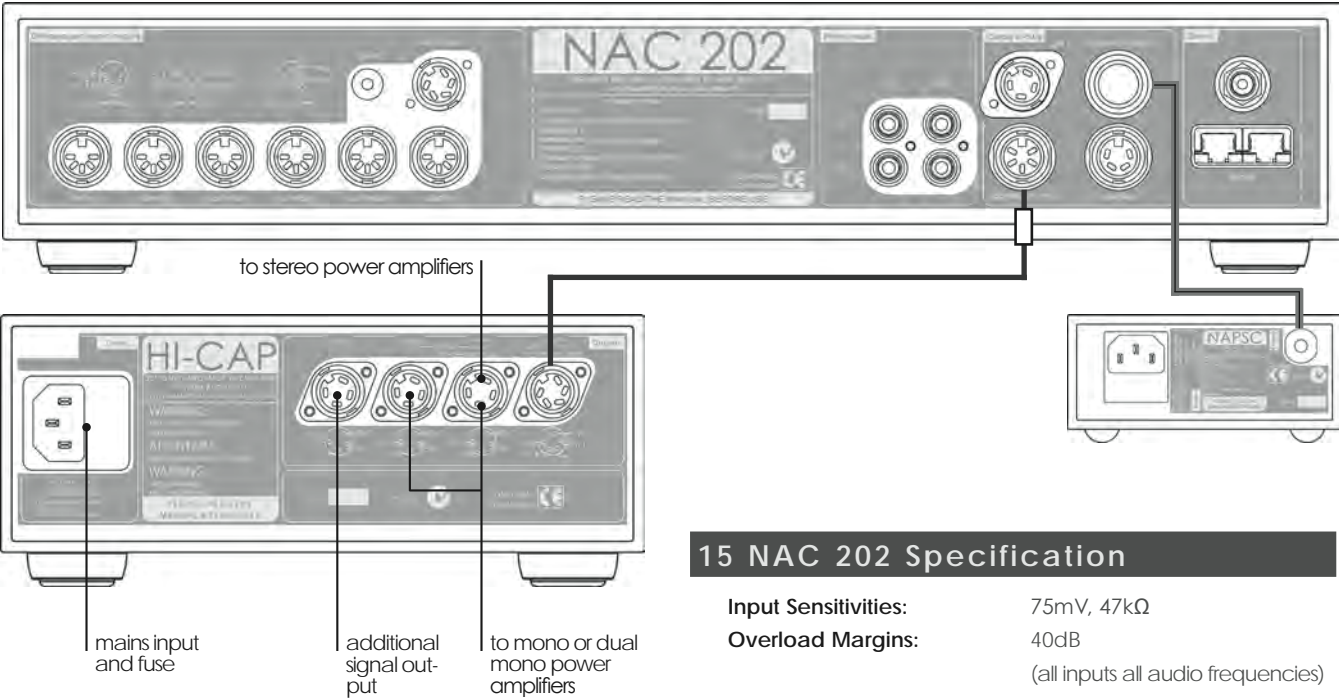

15 NAC 202 Specification

Input Sensitivities:	75mV, 47kΩ
Overload Margins:	40dB
	(all inputs all audio frequencies)
Main Output Level:	0.775V, <50Ω
Tape Output Level:	75mV, 600Ω
Auxiliary Power Outputs:	For Naim phono stage.
Dimensions (H x W x D):	87 x 432 x 314mm
Weight:	7.0kg

NAC 152 XS Preamplifier

16 NAC 152 XS Introduction and Installation

The NAC 152 XS preamplifier does not incorporate an internal power supply but must be used in conjunction with either a Naim power amplifier incorporating a preamplifier power output, or with an appropriate Naim power supply. Diagram 17.3 illustrates the NAC 152 XS connected to a FlatCap XS power supply.

The preamplifier and any power supply should be installed on a dedicated equipment stand intended for the purpose. Do not stand either preamplifier or power supply directly on top of another item of equipment. Ensure that the preamplifier is level.

The preamplifier and any power supply should be installed in their final locations before connecting cables or switching on. Ensure that the preamplifier volume is turned down before switching on.

The following Section 16 paragraphs describe installation features and functions specific to the NAC 152 XS. Operational features common to all preamplifiers and integrated amplifiers are described in Section 28.

Operational features common to all preamplifiers and integrated amplifiers are described in Section 28

16.1 Audio Inputs

The input selection buttons select the source input signal to be routed to the preamplifier outputs and the power amplifier.

The NAC 152 XS has six DIN input sockets and five pairs of RCA Phono sockets. The RCA Phono sockets are permanently connected in parallel with their respective DIN sockets. RCA Phono and DIN sockets for the same input should not be connected simultaneously.

Note: *The aux2 DIN input socket carries a power supply output voltage appropriate for a Naim phono preamplifier.*

A 3.5mm stereo Jack input socket suitable for an iPod (or alternative portable music player) is also provided on the NAC 152 XS front panel. This input is connected in parallel with the aux 1 DIN and RCA Phono sockets.

Insertion of a plug into the front panel socket will automatically switch the preamplifier to that input. Removal of the plug will return the amplifier to the previously selected input. If a different input is selected while a plug is inserted, removal of the plug will not cause the input to change.

16.2 Audio Outputs

The NAC 152 XS provides subwoofer and line level outputs, each via a pair of RCA Phono sockets.

The line level output simply reflects the selected input signal while the subwoofer output is a duplicate of the main preamplifier output (i.e it is affected by the preamplifier volume control).

16.3 Power Supply Upgrades

The NAC 152 XS can be powered by a Naim power amplifier incorporating a preamplifier power supply or its performance upgraded through the connection of one or more external power supplies. Power supply upgrades can be carried out in stages:

Stage 1 is to connect an **i-Supply, Flatcap, Hi-Cap** or **Supercap** power supply to the NAC 152 XS **Upgrade 1** socket. The link/blanking plug inserted in the **Link 1** socket must be removed.

Stage 2 is to connect a **Flatcap, Hi-Cap** or **Supercap** power supply to the NAC 152 XS **Upgrade 2** socket. The link plug fitted to this socket must be removed. With a second power supply added, the NAC 152 XS no longer requires a power supply from the power amplifier, which should now be connected via the Stage 2 power supply.

Diagrams illustrating both power supply upgrade stages are shown in Section 17.

Note: *Link plugs must only be inserted in the sockets from which they were removed and unused power supply sockets must not be used for any other purpose. Incorrect use of link plugs and power supply sockets risks significant damage to the power supply or preamplifier.*

Note: *A wide variety of different power supply schemes are potentially possible for the NAC 152 XS, including the use of one Flatcap for both upgrade stages. Your local retailer will be able to advise on the best scheme for your particular system.*

Note: *The NAPSC power supply cannot be used with the NAC 152 XS.*

NAC 152 XS Preamplifier

17 NAC 152 XS Controls and Connections

17.1 NAC 152 XS Front

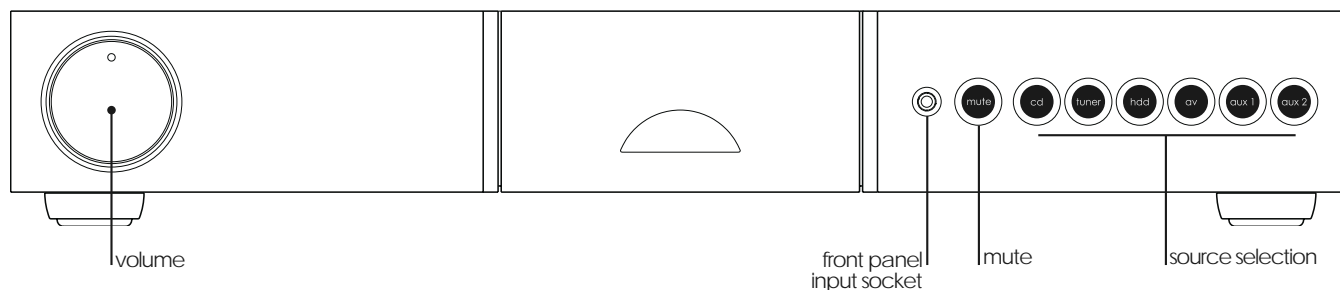

17.2 NAC 152 XS Rear

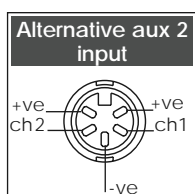
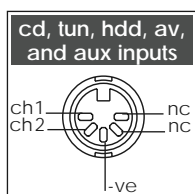
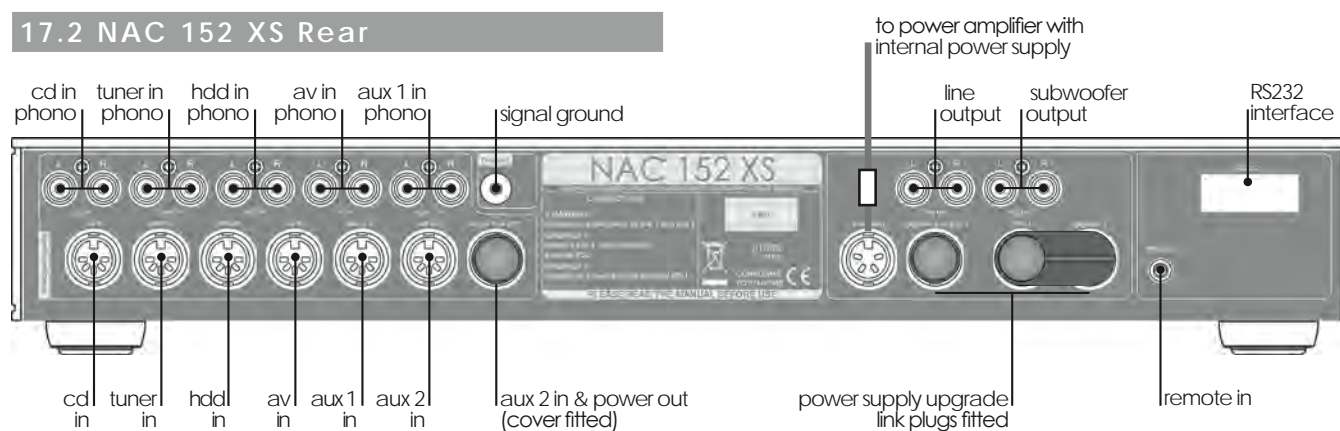

Note: The NAC 152 XS features various technologies to reduce microphonic effects. Some movement of the board and sockets when connecting and disconnecting cables is normal.

Note: The NAC 152 XS AUX 2 input is provided with two sockets. The right hand socket (fitted on delivery with a blanking cover), is intended for use with a Stageline or SuperLine phono stage and incorporates an appropriate DC power supply. The two sockets must not be used simultaneously.

Note: The RS232/comms interface is an optional upgrade. It can be specified at time of order or fitted retrospectively. Contact your local representative or Naim Audio directly for further information.

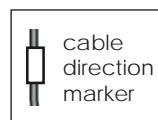

Interconnect Cables	
4 to 4 pin DIN	—
240° 5 to 5 pin DIN	—

NAC 152 XS Preamplifier

17.3 NAC 152 XS Connected to FlatCap XS Power Supply (stage 1 upgrade)

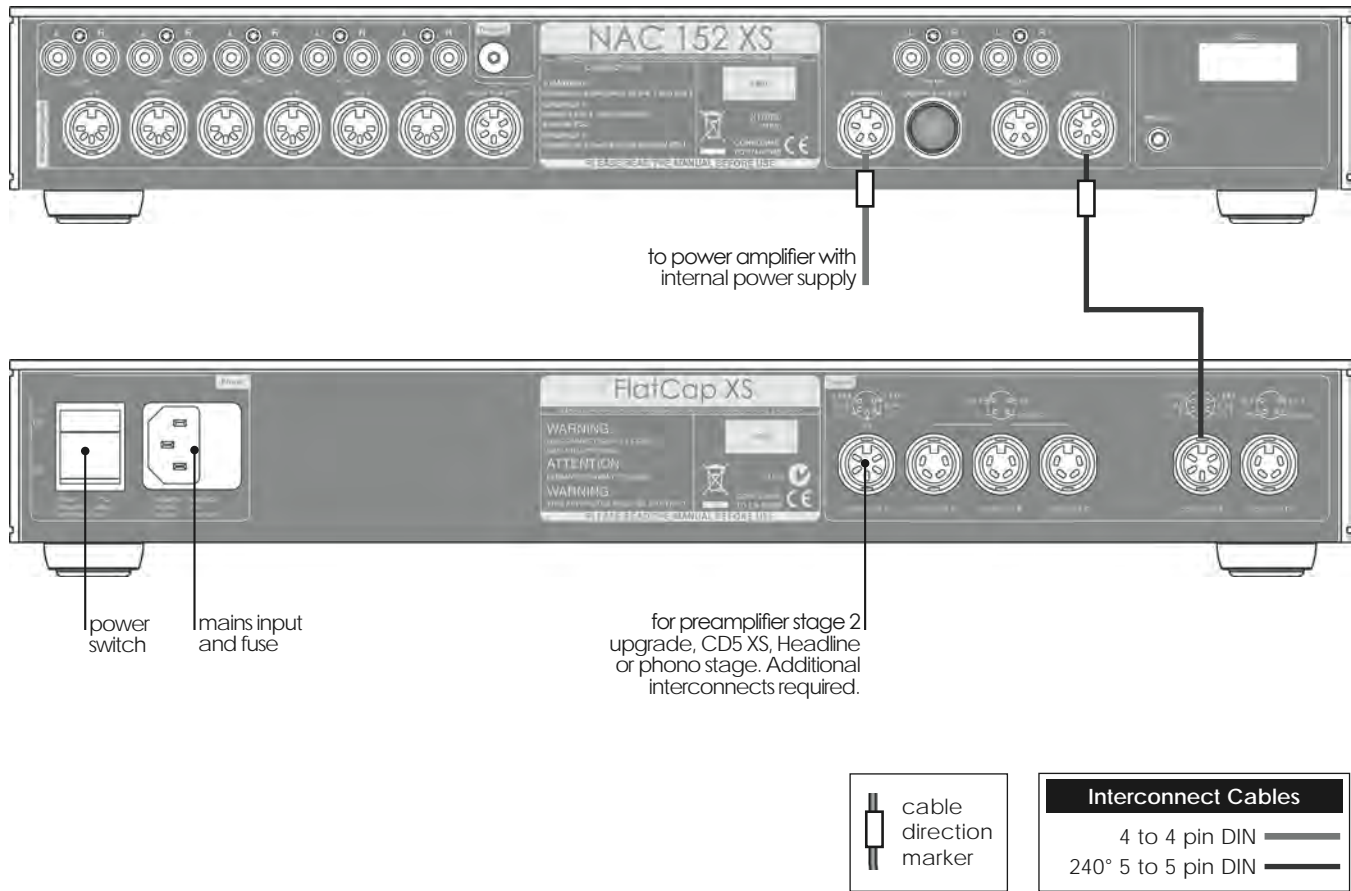

NAC 152 XS Preamplifier

17.4 NAC 152 XS Connected to Hi-Cap and FlatCap XS Power Supplies (stage 2 upgrade)

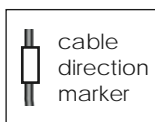
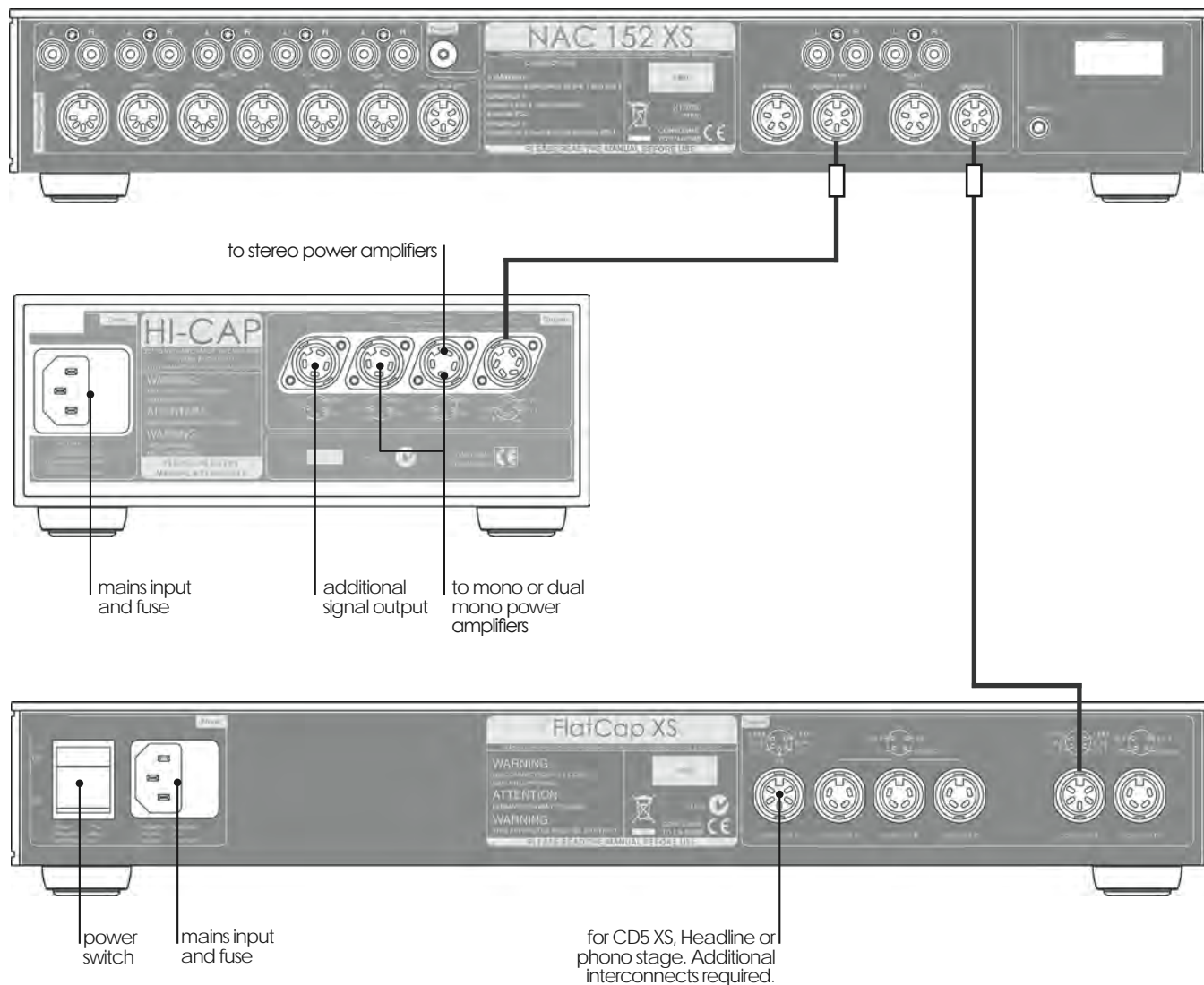

Interconnect Cables	
4 to 4 pin DIN	—
240° 5 to 5 pin DIN	—

18 NAC 152 XS Specification

Input Sensitivities:	130mV, 47kΩ
Overload Margins:	35dB (all inputs all audio frequencies)
Main Output Level:	0.775V, <50Ω
Line Output Level:	130mV, 600Ω
Auxiliary Power Outputs:	For Naim phono stage.
Dimensions (H x W x D):	70 x 432 x 301mm
Weight:	3.9kg

SUPERNAIT Integrated Amplifier

19 SUPERNAIT Introduction and Installation

The Supernait should be installed on a dedicated equipment stand intended for the purpose. Do not stand it directly on top of another item of equipment. Care should be taken to ensure that it is level. The amplifier should be installed in its final location before connecting cables or switching on. Ensure that the volume is turned down before switching on.

A variety of power supply upgrade, alternative preamplifier and alternative or additional power amplifier options are possible for the Supernait. Diagrams illustrating the connection of some of these are shown in Section 20.

The following Section 19 paragraphs describe installation features and functions specific to the Supernait. Operational features common to all preamplifiers and integrated amplifiers are described in Section 28.

Operational features common to all preamplifiers and integrated amplifiers are described in Section 28

19.1 Source Input Selection and Assignment

The input selection buttons arranged along the upper bank select the source signal to be routed to the power amplifier and the loudspeakers. The six buttons are labelled **cd**, **tuner**, **tape**, **av**, **aux1** and **aux2**.

Each input button may be assigned to analogue inputs (via DIN, RCA Phono or 3.5mm jack sockets), or to digital inputs via RCA Phono coaxial, "Toslink" or "mini-toslink" optical sockets. The default settings and the assignment setup procedure are detailed in Sections 19.2 and 19.3 respectively.

19.1.1 Analogue Inputs

The first four selection buttons (cd, tuner, tape and av) can each be assigned to both a DIN input socket and a pair of RCA Phono input sockets on the rear panel. The DIN and Phono sockets for each input are internally wired in parallel and should not be connected simultaneously.

The **aux1** and **aux2** selection buttons can each be assigned to a pair of RCA Phono input sockets and a DIN input socket on the rear panel respectively.

Note: The aux2 DIN input socket carries a power supply output voltage appropriate for a Naim phono preamplifier.

19.1.2 Digital Inputs

The Supernait additionally provides four S/PDIF digital input sockets - 2 RCA Phono coaxial and 2 "Toslink" optical - on the rear panel. Any input selection button can be assigned to one of these sockets.

Note: The digital inputs support stereo PCM audio only. If the digital signal contains anything other than stereo PCM audio (Dolby or DTS encoded programme material for example) all outputs will be muted.

19.1.3 Front Panel Combined Input

An auxiliary front panel input socket is also provided. This socket is a 3.5mm analogue "jack" input combined with a digital "mini-Toslink" optical socket. The analogue input is wired internally in parallel with the rear panel **aux1** input and the two must not be connected simultaneously.

The front panel input (analogue or digital) is automatically selected (and the **aux1** selection button automatically assigned to it), whenever a plug is inserted in the socket.

Note: The Supernait is able to differentiate a digital source from an analogue one at the front panel input if the digital source is working when the plug is inserted.

Input selection will revert to that previously selected when the front panel input plug is removed.

19.2 Default Input Selection Button and Input Socket Assignment

Input Selection Button	Input Socket Assignment	Input Socket Type
cd	Analogue Input 1	DIN/RCA Phono
tuner	Analogue Input 2	DIN/RCA Phono
tape	Digital Input 1	RCA Phono Coax
av	Analogue Input 4	DIN/RCA Phono
aux1 (See Note)	Digital Input 2	"Toslink" Optical
aux2	Analogue Input 6	DIN (with Naim phono stage power supply)

Note: Any plug inserted into the front panel socket will automatically provoke selection of this input (digital or analogue) and will automatically assign it to the aux1 selection button.

SUPERNAIT Integrated Amplifier

19.3 Digital Input Assignment

The default digital input socket assignment illustrated in Table 19.2 may be changed if desired. Each selection button may be assigned to any one of the four rear panel digital input sockets.

Input assignment setup is accessed through the Supernait **program mode**. To switch into (or exit from) program mode press and hold the **prog key** on the remote handset (in preamplifier mode). Program mode is indicated by a flashing indicator on the front panel volume control.

Note: *If no function is operated within five minutes of entering program mode the Supernait will return to normal mode automatically.*

Once in program mode, to assign a digital input socket, first press the required **input** selection button. Then, press one of the **record** selection buttons to assign the desired digital input. The **record** selection buttons assign digital inputs as set out in the following table:

Record Select Button		Digital Input Selection
cd	(assigns)	digital 1 (coaxial)
tuner	(assigns)	digital 2 (optical)
tape	(assigns)	digital 3 (coaxial)
av	(assigns)	digital 4 (optical)

As an example, to assign the **tuner** input selection button to **digital input 4** proceed as follows.

- i) Enter program mode.
- ii) Press the **tuner** input selection button.
- iii) Press the **av** record selection button (which will illuminate).
- iv) Exit program mode.

To return an input selection button to its default analogue input, repeat the assignment procedure.

For example, to return the **tuner** input selection button to its analogue input socket.

- i) Enter program mode.
- ii) Press the **tuner** input selection button.
- iii) Press the **av** (illuminated) record selection button (which will extinguish).
- iv) Exit program mode.

19.4 Record Outputs

The selection buttons arranged along the lower bank select the source signal to be routed to the Supernait's record outputs.

These separate source and record sections enable one source (a CD player, for example) to be listened to whilst the output from another (say, the tuner) is simultaneously selected for recording.

Note: *Simultaneous and independent listen and record is not possible with two digital sources.*

19.5 Speaker Outputs

A stereo set of speaker connection sockets is provided on the rear panel. Custom Naim Audio loudspeaker connectors are supplied to make the connection and in order to comply with current European safety regulations these should always be used. Naim Audio speaker cable will provide the best results; however, a wide range of speaker cable types can be used without risk of damage to the amplifier.

Ensure when connecting speakers that they are "in phase". That is, the positive and negative connection orientation at both the speaker and amplifier ends of the cable is the same for both channels.

19.6 Headphone Output

A 3.5mm headphone socket is provided on the front panel. Insertion of a headphone plug will automatically switch on the headphone amplifier and mute the speaker outputs unless the Supernait is set up not to mute.

To prevent (or re-enable) automatic speaker muting, enter program mode and press the **record aux2** selection button.

19.7 Auxiliary Inputs and Outputs

A **bi-amp out** (preamplifier output) DIN socket is provided on the rear panel to enable an external upgrade power amplifier or second (bi-amp) power amplifier to be used.

Note: *Bi-amp out is the preferred socket for all external power amplifier connections.*

Also provided are separate **pre-amp out** and **power-amp in** sockets. In normal use these sockets are connected by an external link plug. The link plug should be removed only if a power supply upgrade is to be used or an alternative preamplifier is to use the Supernait power amplifier section. Diagrams 20.3 to 20.5 illustrate use of these sockets.

When an external preamplifier is connected to the Supernait **power-amp in** socket, a fault will initially be indicated by the **source mute** button flashing. To clear the fault, press and hold the flashing **source mute** button. This will un-mute the power amplifier and turn off the display and volume and balance indicators.

The Supernait provides an unfiltered analogue stereo **subwoofer** output via a pair of RCA Phono sockets.

Note: *The subwoofer output is a duplicate of the preamplifier output. No low-pass filtering is applied.*

19.8 Power Supply Upgrades

The Supernait preamplifier section can be upgraded through the connection of an external Flatcap, Hi-Cap or Supercap power supply. Diagrams illustrating power supply upgrades are shown in the following section. The Supernait

SUPERNAIT Integrated Amplifier

and external power supply must be switched off when connections are made. Switch on the external power supply and then the Supernait when all connections are complete.

19.9 General Connections Notes

The Supernait negative input and output connections for each channel are common. The mains earth (ground)

should always be connected regardless of what other equipment is used in conjunction with the amplifier. The mains earth only grounds the case and the electrostatic screen within the transformer, and is not connected to the signal negative. In order to avoid hum loops, the signal negative of the whole system should be connected to the mains earth (ground) in one place.

20 SUPERNAIT Controls and Connections

20.1 SUPERNAIT Front

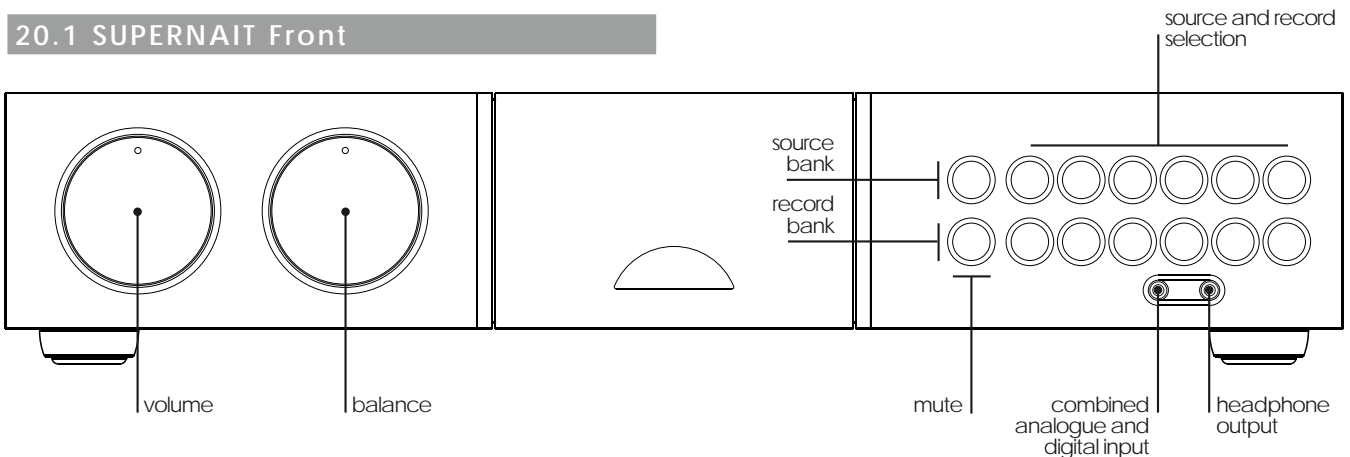

20.2 SUPERNAIT Rear

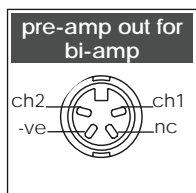
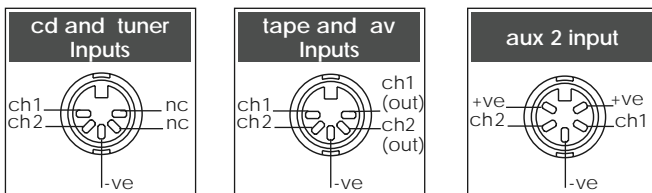
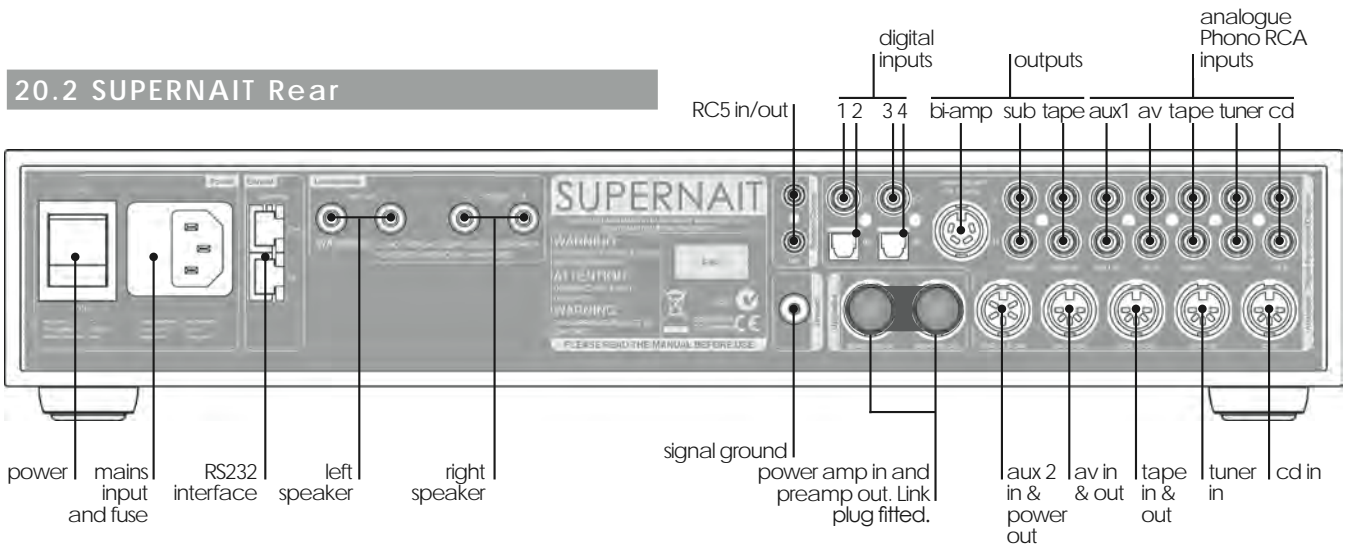

Note: The RS232 interface is an optional upgrade. It can be specified at time of order or fitted retrospectively. Contact your local representative or Naim Audio directly for further information.

Note: The link plug should be removed only if a power supply upgrade is to be used or an alternative preamplifier is to use the Supernait power amplifier section. It should remain fitted in all other circumstances.

SUPERNAIT Integrated Amplifier

20.5 SUPERNAIT Connected to Hi-Cap Power Supply and NAP 200 Power Amplifier

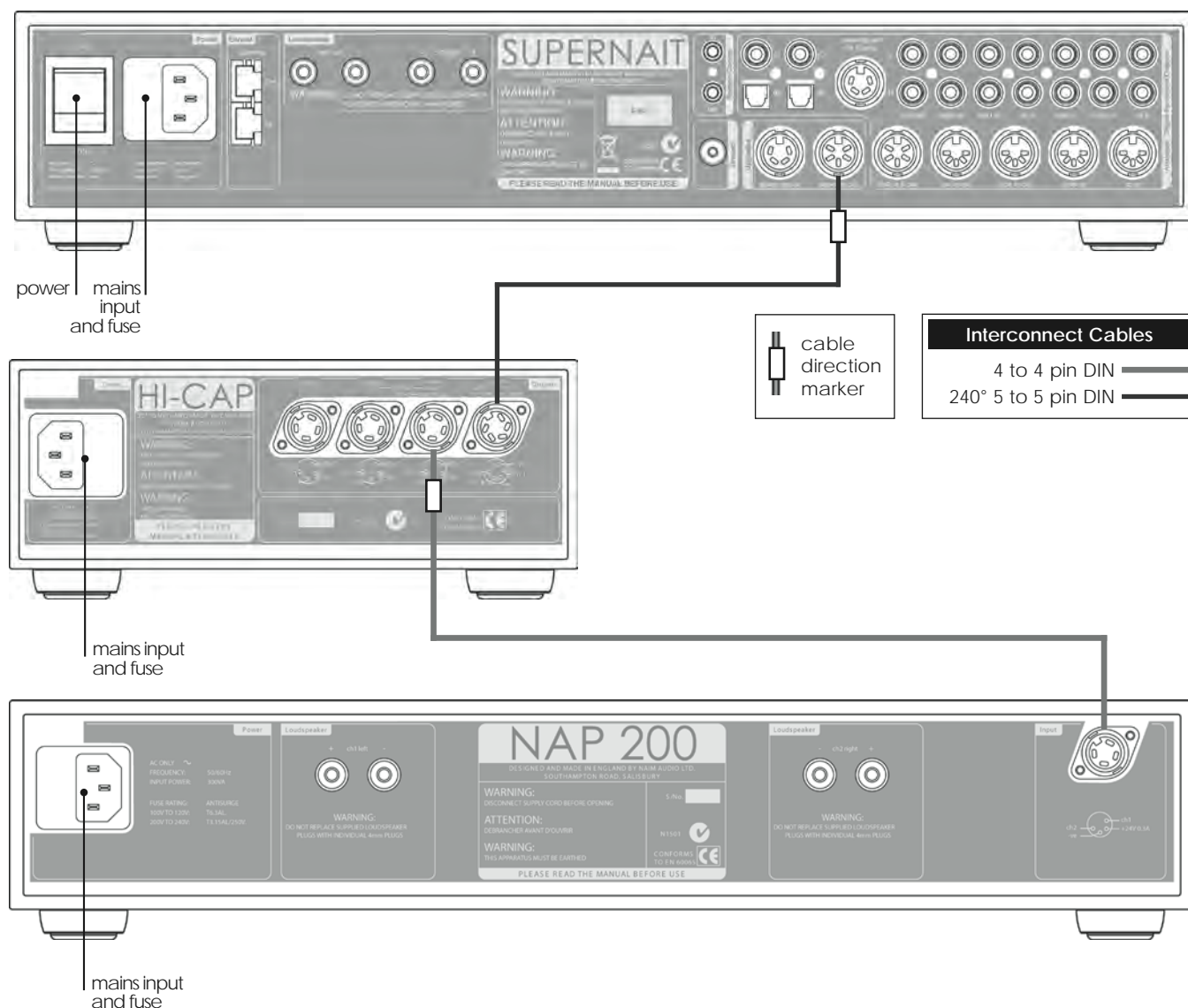

21 SUPERNAIT Specification

Input Sensitivities:	75mV, 47k Ω
Overload Margins:	40dB (all inputs all audio frequencies)
Preamp Output Level:	0.775V, <50 Ω
Tape Output Level:	75mV, 600 Ω
Power Output:	Continuous 80 Watts per channel into 8 Ohms
Auxiliary Power Outputs:	For Naim phono stage
Quiescent Consumption:	10VA
Dimensions (H x W x D):	87 x 432 x 314mm
Weight:	12.8kg
Mains Supply:	100-120V or 220-240V, 50/60Hz

NAIT XS Integrated Amplifier

22 NAIT XS Introduction, Installation and Connections

The NAIT XS should be installed on a dedicated equipment stand intended for the purpose. Do not stand it directly on top of another item of equipment. Care should be taken to ensure that it is level. The amplifier should be installed in its final location before connecting cables or switching on. Ensure that the volume is turned down before switching on.

A variety of power supply upgrade, alternative preamplifier and alternative or additional power amplifier options are possible for the NAIT XS. Diagrams illustrating the connection of some of these are shown in Section 23. Contact your local retailer or distributor for advice on further alternative connection schemes.

The NAIT XS incorporates an AV Bypass switch on its rear panel. The switch should only be set to “On” if the amplifier is to be used in conjunction with an AV processor in a home theatre system. In all other installations the AV Bypass switch should be set to “Off”. Speaker and/or amplifier damage may occur if a signal is inadvertently connected to the NAIT XS av input while the AV Bypass switch is “On”.

Operational features common to all preamplifiers and integrated amplifiers are described in Section 28.

Operational features common to all preamplifiers and integrated amplifiers are described in Section 28

22.1 Mains Power Connection

Connect the NAIT XS to a mains power socket using either the mains cable supplied or a Naim Power-Line.

22.2 Signal Inputs

The NAIT XS front panel input buttons select the source input signal to be routed to the integral power amplifier and the loudspeakers. The six buttons are labelled **cd**, **tuner**, **hdd**, **av**, **aux 1** and **aux 2**.

The **cd**, **tuner**, **hdd** and **av** input buttons select parallel DIN and RCA phono input sockets on the rear panel.

Note: The *hdd* and *av* sockets carry both inputs and outputs. See Section 22.4 for more information.

The **aux 1** input button corresponds to a pair of RCA phono sockets on the rear panel and a parallel 3.5mm stereo jack socket on the front panel. Insertion of a plug into the front panel **aux 1** socket will automatically switch the amplifier to that input. Removal of the plug will return the amplifier to the previously selected input. If a different input is selected while a plug is inserted removal of the plug will not cause the input to change.

The **aux 2** input button corresponds to a DIN input socket on the rear panel. The **aux 2** DIN socket also carries a power supply output suitable to power a Naim **Stageline** or **SuperLine** phono preamplifier.

Note: For optimum sound quality DIN sockets should be used in preference to RCA phono sockets.

Note: Where an input has DIN or Phono socket options only one should be connected at any one time.

Always use high quality interconnect cables to connect sources to inputs. The Naim Hi-Line will produce the best results.

22.3 Speaker Outputs

A set of stereo speaker connection sockets is provided on the rear panel. Custom Naim loudspeaker connectors are supplied to make the connection and in order to comply with current European safety regulations these should always be used. Naim speaker cable will provide the best results, however, a wide range of speaker cable types can be used without risk of damage to the amplifier.

Ensure when connecting speakers that they are “in phase”. That is, the positive and negative connection orientation at both the speaker and amplifier ends of the cable is the same for both channels.

22.4 AV and hdd Inputs and Outputs

The NAIT XS **av** and **hdd** inputs have associated outputs that enable the selected input signal to be routed externally; to an audio recording component for example.

Note: The *av* or *hdd* outputs will be muted if their corresponding inputs are selected.

22.5 AV Bypass

The NAIT XS can be integrated within a multi-channel home theatre system, driving the front left and right channel speakers, by engaging its AV Bypass mode. AV Bypass mode enables a home theatre processor to take over volume control of signals connected to the NAIT XS **av** input. It is engaged using the switch on the rear panel. The NAIT XS volume control indicator will extinguish when AV Bypass mode is engaged and the **av** input is selected. The remote handset volume control will also be disabled.

NAIT XS Integrated Amplifier

Note: The AV Bypass feature must be used with care. It bypasses the NAIT XS volume control leaving any signal connected to the av input to be passed to the speakers at full volume.

Note: The mute function is disabled when AV Bypass is engaged.

22.6 Auxiliary Inputs and Outputs

The NAIT XS incorporates **pre-amp out** and **power-amp in** sockets on its rear panel. In normal use these sockets are connected by a link plug. The link plug should be removed only in the following circumstances:

- A power supply upgrade is to be used.
- An alternative preamplifier is to use the NAIT XS power amplifier section.
- An alternative power amplifier is to use the NAIT XS preamplifier section.

Diagrams 23.3 and 23.4 illustrate use of these sockets.

When an external preamplifier is connected to the NAIT XS **power-amp in** socket, a fault will initially be indicated by the **mute** button flashing. To clear the fault, press and hold the flashing **mute** button. This will un-mute the amplifier and turn off the display and volume indicator.

The NAIT XS provides an unfiltered analogue stereo **subwoofer** output via a pair of RCA phono sockets.

Note: The subwoofer output is a duplicate of the preamplifier output. No low-pass filtering is applied.

22.7 Power Supply Upgrades

The NAIT XS preamplifier section can be upgraded through the connection of an external Flatcap, Hi-Cap or Supercap power supply. Diagrams illustrating power supply upgrades are shown in Section 23. The NAIT XS and external power supply must be switched off when connections are made. Switch on the external power supply first followed by the NAIT XS when all connections are complete.

22.8 General Connections Notes

The NAIT XS negative input and output connections for each channel are common. The mains earth (ground) should always be connected regardless of what other equipment is used in conjunction with the amplifier. The mains earth only grounds the case and the electrostatic screen within the transformer, and is not connected to the signal negative. In order to avoid hum loops, the signal negative of the whole system should be connected to the mains earth (ground) in one place.

A signal ground connection is fitted to the NAIT XS rear panel. This is intended to be used to connect a turntable pick-up arm signal earth only.

23 NAIT XS Controls and Connections

23.1 NAIT XS Front

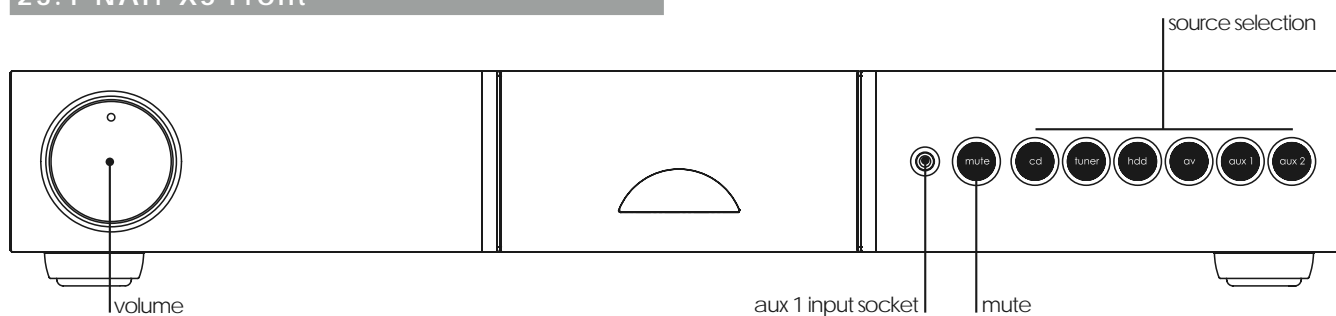

NAIT XS Integrated Amplifier

23.2 NAIT XS Rear

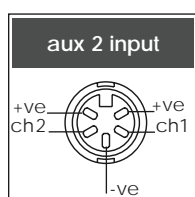
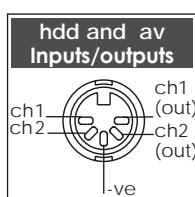
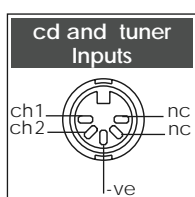
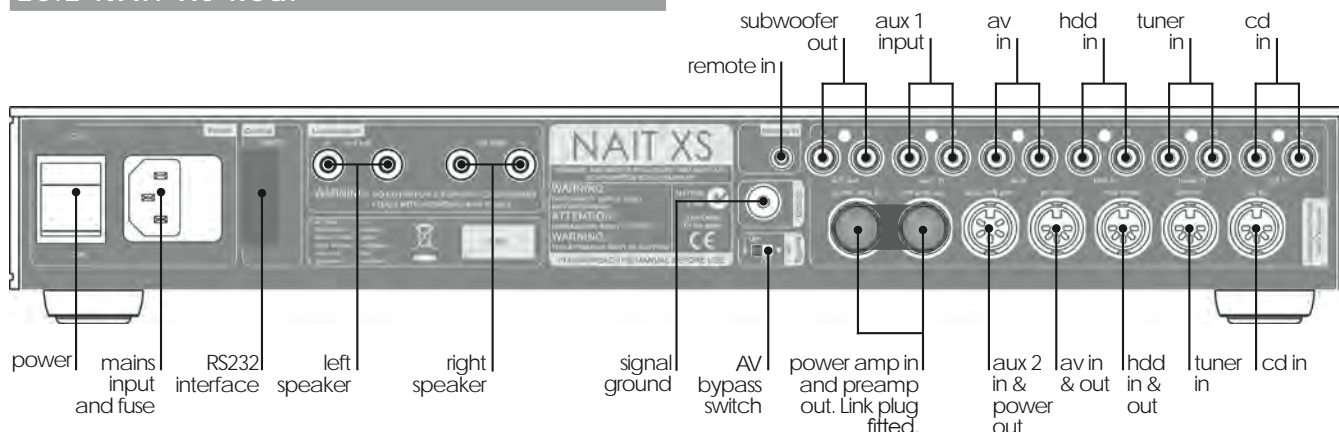

Note: The RS232 interface is an optional upgrade. It can be specified at time of order or fitted retrospectively. Contact your local representative or Naim directly for further information.

Note: The link plug should be removed only if a power supply upgrade is to be used, an alternative preamplifier is to use the NAIT XS power amplifier section, or an alternative power amplifier is to use the NAIT XS preamplifier section. It should remain fitted in all other circumstances.

Note: The Nait XS features various technologies to reduce microphonic effects. Some movement of the board and sockets when connecting and disconnecting cables is normal.

23.3 NAIT XS Connected to FlatCap XS Power Supply

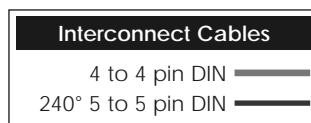
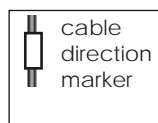
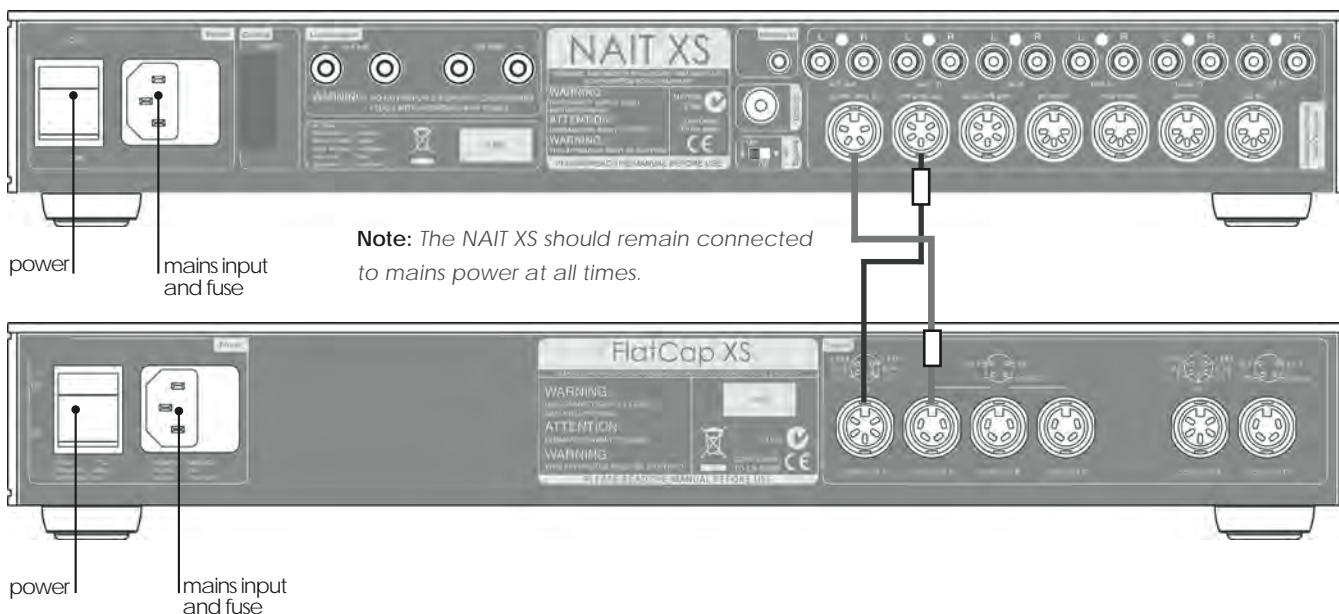

NAIT XS Integrated Amplifier

23.4 NAIT XS Connected to Hi-Cap Power Supply and NAP 200 Power Amplifier

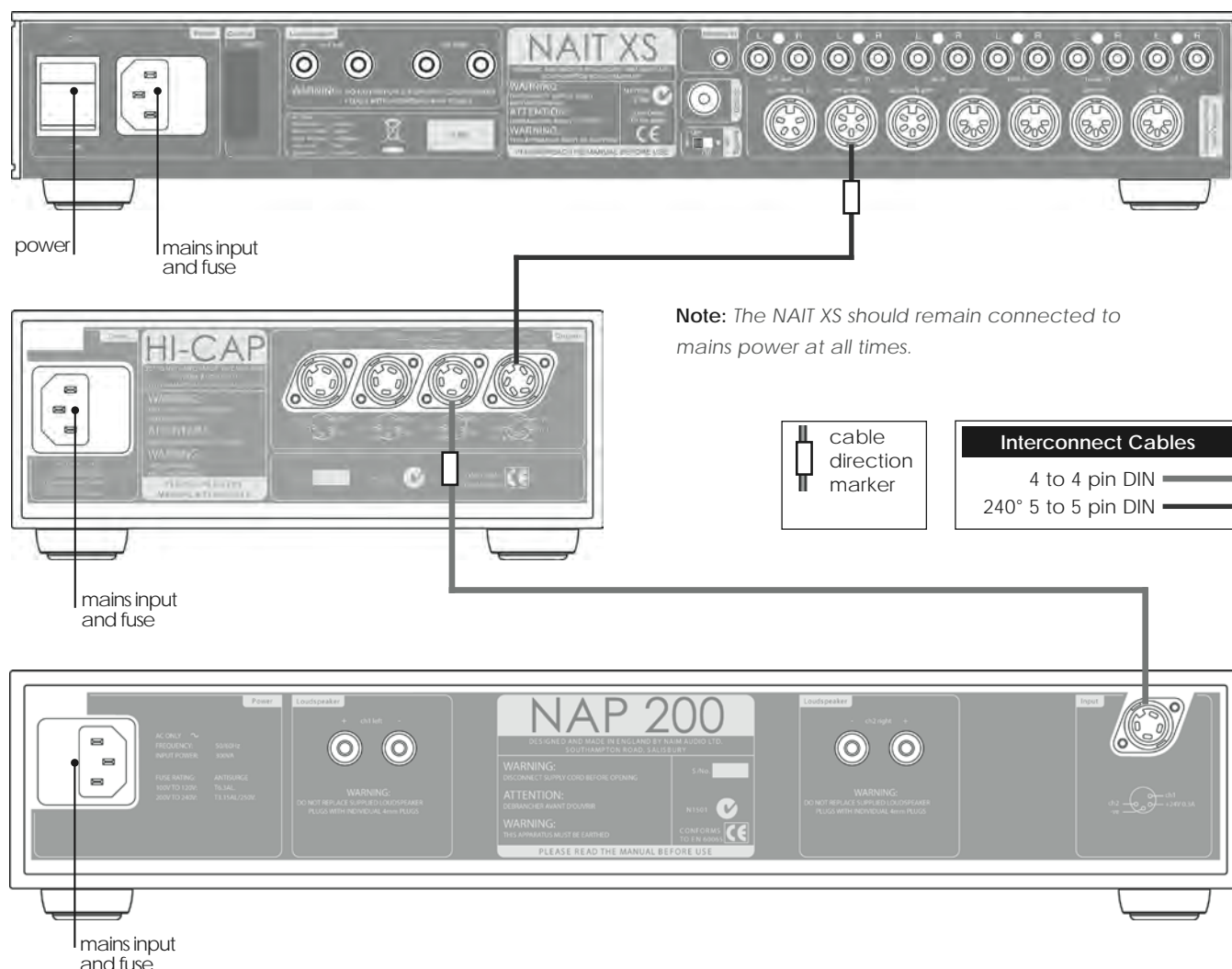

24 NAIT XS Specification

Input Sensitivities:	130mV, 47kΩ
Overload Margins:	34dB
	(all inputs all audio frequencies)
Preamp Output Level:	0.775V, <50Ω
Line Output Level:	130mV, 600Ω
Power Output:	Continuous 60 Watts per channel into 8 Ohms
Auxiliary Power Outputs:	For Naim phono stage
Quiescent Consumption:	20VA
Dimensions (H x W x D):	70 x 432 x 301mm
Weight:	8.6kg
Mains Supply:	100-120V or 220-240V, 50/60Hz

NAIT 5i Integrated Amplifier

25 NAIT 5i Introduction and Installation

The Nait 5i should be installed on a dedicated equipment stand intended for the purpose. Do not stand it directly on top of another item of equipment. Care should be taken to ensure that it is level. The amplifier should be installed in its final location before connecting cables or switching on. Ensure that the volume is turned down before switching on.

Operational features common to all preamplifiers and integrated amplifiers are described in Section 28

The following Section 25 paragraphs describe installation features and functions specific to the Nait 5i. Operational features common to all preamplifiers and integrated amplifiers are described in Section 28.

25.1 Inputs

The front panel input selector buttons select the source input signal to be routed to the power amplifier and the loudspeakers. The four buttons are labelled cd, tuner, hdd and av. Each input button corresponds to a pair of rear panel RCA Phono input sockets. The cd and tuner inputs are additionally provided with alternative DIN sockets. These should be used in preference to the RCA Phono sockets if practical. Do not connect both the DIN and RCA Phono sockets of one input simultaneously.

A 3.5mm stereo Jack input socket suitable for an iPod* (or alternative portable music player) on is also provided on the Nait 5i front panel.

Insertion of a plug into the front panel socket will automatically switch the preamplifier to that input. Removal of the plug will return the amplifier to the previously selected input.

Note: The mute function will not operate when the front panel input is in use.

25.2 Outputs

A stereo set of speaker connection sockets is provided on the rear panel. The sockets can accept standard 4mm plugs, but to comply with European legislation the Naim connectors supplied should be used. Naim Audio speaker cable will provide the best results; however, a wide range of speaker cable types can be used without risk of damage to the amplifier.

Ensure when connecting speakers that they are "in phase". That is, the positive and negative connection orientation at both the speaker and amplifier ends of the cable is the same for both channels.

The hdd output always carries the selected input signal.

26 NAIT 5i Controls and Connections

26.1 NAIT 5i Front

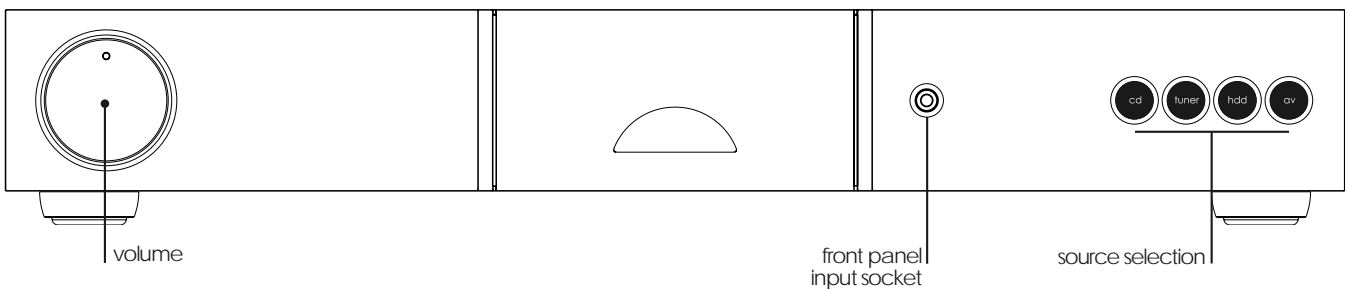

NAIT 5i Integrated Amplifier

26.2 NAIT 5i Rear

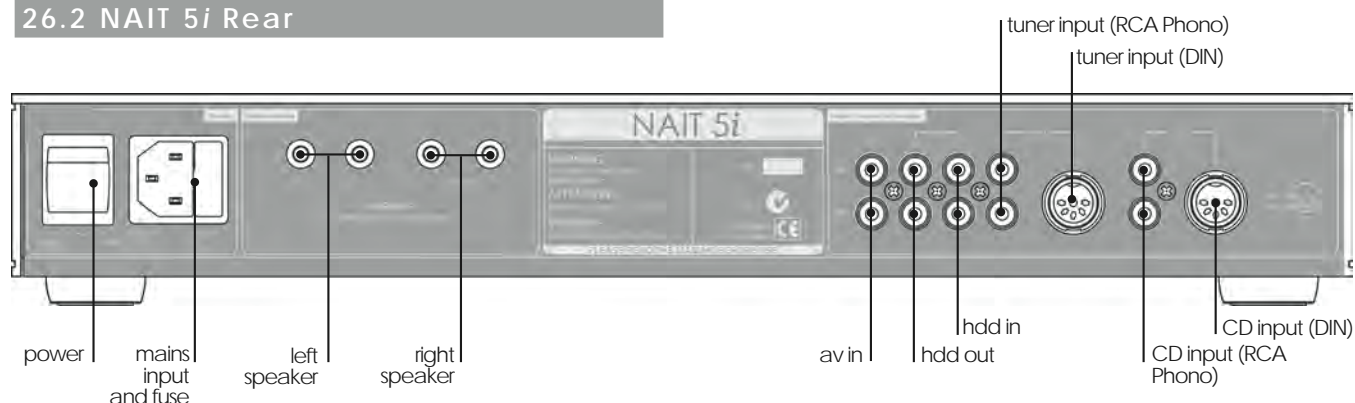

Note: The Nait 5i features various technologies to reduce microphonic effects. Some movement of the board and sockets when connecting and disconnecting cables is normal.

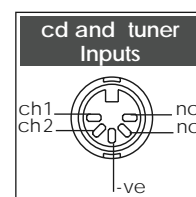

27 NAIT 5i Specification

Input Sensitivities:	225mV, 20k Ω
Overload Margins:	35dB (all inputs all audio frequencies)
Tape Output Level:	225mV, 100 Ω
Power Output:	Continuous 50 Watts per channel into 8 Ohms
Quiescent Consumption:	10VA
Dimensions (H x W x D):	70 x 432 x 301mm
Weight:	6.4kg
Mains Supply:	100-120V or 220-240V, 50/60Hz

Preamplifier and Integrated Amplifier Operation

28 Preamplifier and Integrated Amplifier Operation

Many operational and control features of Naim preamplifiers and integrated amplifiers are common to all and are based on a similar user interface. This section of the manual describes those features and the user interface, drawing attention to differences between products where they occur. Table 28.10 sets out some variations in user interface between products.

Front panel controls are duplicated on the remote control handset which may also provide some extra functions. See Sections 29 and 30 for more information.

For the purposes of brevity the term preamplifier in the following paragraphs can be taken also to mean integrated amplifier.

28.1 Automatic Input Switching

With **Automatic Input Switching** engaged the appropriate source input will be selected as soon as any handset function for that (Naim) source component is operated. For example, if the tuner input is selected and the cd play key is pressed on the handset, the preamplifier will automatically switch to the cd input. Automatic Input Switching can be programmed to operate on any combination of the cd, av, hdd and tuner input buttons (and sockets to which they are assigned).

To enable Automatic Input Switching, first switch the preamplifier into program mode by pressing and holding the handset **prog** key (with the handset in preamplifier mode). The front panel **source mono/mon** button (NAC 202 **mon** and NAC 152 XS **mute** buttons, Supernait **record mute** button, Nait XS **mute** button and Nait 5i **hdd** button) will illuminate if automatic switching is already enabled. If it is not enabled it can be switched on by pressing the same button.

With automatic switching enabled, pressing the button again will reveal the inputs selected for auto switching by their indicators illuminating for a short time. Repeated operation of the button will sequentially select through each possible combination of cd, av, hdd, and tuner inputs and auto switching disabled (all indicators off). When the desired inputs selected for auto switching are indicated, stop pressing the button.

Automatic Input Switching only becomes operational on exit from program mode by pressing and holding the handset **prog** key.

Note: *The preamplifier will leave program mode automatically if no control commands are received for five minutes.*

Note: *In a few cases some further equipment configuration may be required for auto switching to operate correctly. Please contact your retailer or local distributor for advice.*

28.2 AV Integration (Unity Gain)

Unity Gain enables an audio-visual processor to be integrated such that its volume control takes over command of signals connected to selected preamplifier inputs. On the NAC 552 Unity Gain may be selected on DIN input sockets **4** and **5**. On all other preamplifiers it may be selected on only the **av** input.

To select Unity Gain, first switch the preamplifier into program mode by pressing and holding the handset **prog** key (with the handset in preamplifier mode). The front panel **source mute** button (NAC 202 **mute** button, NAC 152 XS and Nait 5i **av** button) will illuminate if Unity Gain is selected. If it is not enabled it can be switched on by pressing the same button twice.

Note: *Unity Gain (AV Bypass) on the Nait XS is not engaged in program mode but via a rear panel switch.*

With Unity Gain enabled on the NAC 552, pressing the **source mute** button again will reveal the inputs selected by their indicators illuminating for a short time. Repeated operation of the button will sequentially select each combination of the available inputs, and Unity Gain disabled. When the desired inputs are indicated, stop pressing the button. The selected inputs will then be enabled for Unity Gain. The handset can also be used to select Unity Gain. See table 28.10.

Unity Gain only becomes operational on exit from program mode by pressing and holding the handset **prog** key.

Note: *The preamplifier will leave program mode automatically if no control commands are received for five minutes.*

Preamplifier and Integrated Amplifier Operation

Note: The Unity Gain feature must be used with care. It effectively by-passes the preamplifier volume and balance controls leaving any signal connected to a Unity Gain input to be passed to the power amplifier and speakers at full volume. In order to reduce the potential for inadvertent mishap, any subsequent modifications to input assignment will automatically disable previously set up Unity Gain inputs. Additionally, if an input is selected which has Unity Gain enabled, the preamplifier volume and balance handset functions will be disabled and their indicators will turn off. This will be flagged by the volume or balance indicators flashing if either handset function is operated.

28.3 Handset Volume and Balance Control

The remote handset **volume** and **balance** keys provide some alternative control characteristics. A quick press and release of a key will adjust by a preset "nudge". A quick press and release of a key followed by press and hold will cause continual slow adjustment. Simple press and hold will cause continual fast adjustment.

Note: The NAC 152 XS, Nait XS and Nait 5i do not incorporate any facility for channel balance control.

28.4 Mute, Mono and Mon

Mute silences the output signal and can be selected by pressing the front panel **mute** button. On preamplifiers equipped with separate source and record sections Mute can be selected independently for source and record. Mute can also be selected from the handset.

Note: The Nait 5i does not incorporate any front panel mute facility.

Some preamplifiers include a **mon** (mono) function that sums the left and right channels. Mono can be selected by pressing the front panel **mon** (NAC 552 **mono**) button. On preamplifiers equipped with separate source and record sections mono can be selected independently for source and record. Mono can also be selected from the handset.

Note: The NAC 202, NAC 152 XS, Supernait, Nait XS and Nait 5i do not incorporate any mono facility.

The NAC 202 incorporates a **mon** ("tape monitor") function. Pressing the **mon** button routes the **tape**, **av** or **aux 1** input signals to the preamplifier output while leaving the input selection routed to the **tape**, **av** and **aux 1** outputs. The **mon** function can also be selected from the handset.

Note: Only the **tape**, **av** and **aux 1** inputs (those that incorporate outputs) can be selected when **mon** is engaged. However, if one of these inputs carries the source signal, that input will be unavailable for monitoring.

Note: As delivered the NAC 202 record mute function is engaged. It can be disengaged by pressing the mute button while **mon** is engaged. See Section 13.2

Note: The NAC 152 XS, Nait XS and Nait 5i do not incorporate any front panel tape monitor facility.

28.5 Display

The preamplifier front panel button illumination can be switched off by pressing the remote handset (in preamplifier mode) **disp** function. Any subsequent handset or front panel operation will temporarily restore the display. A second operation of the **disp** function will restore the display.

28.6 Switch-on

After switch-on, via the power amplifier or power supply **power** button, the preamplifier will remain muted for 30 seconds while control systems and circuits stabilise. On preamplifiers equipped with separate source and record sections, only the source side will un-mute automatically leaving the record side muted.

28.7 Remote Control

The remote handset supplied with the preamplifier duplicates all configuration and control functions. See Sections 29 and 30 for more information.

28.8 Defaults

To restore all programmable settings to the factory defaults press and hold the remote handset **disp** key while the preamplifier is in program mode. The preamplifier will exit from program mode following this operation.















Preamplifier and Integrated Amplifier Operation

28.9 Fault Conditions

Some amplifiers will indicate problems by flashing front panel button indicators. The following diagram tabulates the fault indication for each product.

Amplifier	Power Supply or Link Plug Fault Flashing Button	Over Current Fault Flashing Button	Over Temperature Fault Flashing Button
NAC 252	source mute	N/A	N/A
NAC 282	source mute	N/A	N/A
NAC 202	mute	N/A	N/A
NAC 152 XS	mute	N/A	N/A
Supernait	source mute	record mute	N/A
Nait XS	mute	tuner	N/A
Nait 5i	N/A	tuner	cd

28.10 Interface Function Buttons and Keys

Amplifier	Program Mode	Auto Input Switching	AV Integration (Unity Gain)	Restore Defaults	
NAC 552	hold pre	N/A	N/A	N/A	handset key (R-com)
	hold prog	pre  mon source mono	pre  mute source mute	hold disp	handset key(s) (NARCOM 4) front panel
NAC 252	hold prog	pre  mon source mon	pre  mute source mute	hold disp	handset key(s) (NARCOM 4) front panel button
NAC 282	hold prog	pre  mon source mon	pre  mute source mute	hold disp	handset key(s) (NARCOM 4) front panel button
NAC 202	hold prog	pre  mon mon	pre  mute mute	hold disp	handset key(s) (NARCOM 4) front panel button
NAC 152 XS	hold prog	pre  mute mute	pre  av av	hold disp	handset key(s) (NARCOM 4) front panel button
Supernait	hold prog	rec  mute record mute	pre  mute source mute	hold disp	handset key(s) (NARCOM 4) front panel button
Nait XS	hold prog	pre  mute mute	rear panel switch	hold disp	handset key(s) (NARCOM 4) front panel button
Nait 5i	hold prog	pre  3 hdd	pre  4 av	hold disp	handset key(s) (NARCOM 4) front panel button

Note: The handset must be in preamplifier mode to select program mode or to restore defaults

Note: The  symbol means one key followed by another.

R-com Remote Handset

29 R-com Remote Handset

The R-com remote handset is supplied with the NAC 552 and CD555 and can be purchased as an accessory. It offers quick and intuitive control of the most often used functions of CD players, preamplifiers, integrated amplifiers and tuners.

To fit batteries, remove the bottom end cover using the tool provided and insert the batteries into the body taking care with their orientation. Replace the end cover. Remove the batteries if the R-com is to be packed and shipped.

29.1 Using R-com

R-com keys primarily provide control of the functions most often used on CD players, preamplifiers, integrated amplifiers and tuners. In order to extend battery life, R-com will enter a "sleep" mode when unused. It will "wake" on being touched.

R-com has three operational modes - CD Player mode, Preamplifier/Integrated amplifier mode and Tuner mode. Its default mode is CD player. When awake in CD Player mode, all R-com keys will illuminate green. To switch the R-com into Preamplifier/Integrated amplifier mode or Tuner mode press the **pre** or **tun** keys respectively. The **pre** or **tun** key will then illuminate white. To switch R-com back into CD player mode either press the **pre** or **tun** key again.

In default mode the R-com keys have the following functions:

- disp:** Scrolls through the display options of track, time and display off.
- open:** Opens the door on the CD555.
- stop:** Stops CD replay.
- play:** Begins CD replay.
- prev:** Selects the previous track or index point.
- next:** Selects the next track or index point.
- vol +:** Increases the preamplifier/integrated amplifier volume.
- vol -:** Decreases the preamplifier/integrated amplifier volume.
- mute:** Reduces the volume to zero. A second press restores the volume.
- pause:** Pauses CD replay. A second press restores play.

In Preamplifier/Integrated amplifier mode (press **pre** key), the following keys will change function:

- disp:** Switches the preamplifier/integrated amplifier front panel button indicators & knob indicators off and on.
- prev:** Selects the previous source input.
- next:** Selects the next source input.

Note: Preamplifier or integrated amplifier program mode can be selected from the R-com by pressing and holding the **pre** key. Program mode functions can then be accessed from the equipment front panel.

In Tuner mode (press **tun** key) the following keys will change function:

- disp:** Switches the tuner display and front panel button indicators off and on.
- prev:** Selects the tuner "down" function.
- next:** Selects the tuner "up" function.

Note: Tuner modes can be selected from the R-com by an extended press of the **tun** key.

29.2 R-com Keys

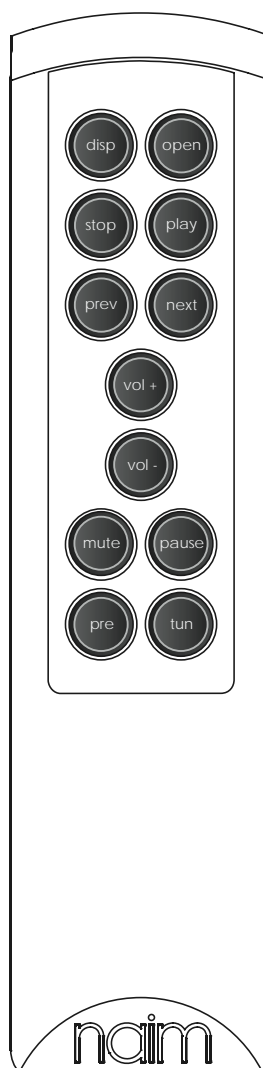

NARCOM 4 Remote Handset

30 NARCOM 4 Remote Handset

The NARCOM 4 remote handset is supplied with the NAC 552, NAC 252, NAC 282, NAC 202, NAC 152 XS, Supernait, Nait XS and Nait 5i. It is a multi-functional remote control handset designed to be used with Naim Audio CD players, integrated amplifiers, preamplifiers, preset tuners and subwoofers.

To fit batteries, remove the battery cover and insert the batteries into the body taking care with their orientation. Replace the battery cover.

30.1 Using NARCOM

Operation of the NARCOM 4 handset is based around three types of keys: **System Component Keys**, **Global Keys** and **Soft Keys**.

System Component Keys keys switch the operation of the **Soft Keys** into modes appropriate to each system component (CD player, preamplifier, etc.).

Global Keys operate specific component functions regardless of the **System Component Key** setting and are available at all times.

Preamplifier and Integrated Amplifier **Global Keys** operate as follows:

- vol** (🔊 & 🔇) Adjusts the preamplifier volume and the volume control position.
- mute** Reduces the preamplifier volume to zero. A second press restores the volume.
- bal** (🔊 & 🔊) Adjusts the channel balance. Some Naim amplifiers have control of channel balance available only from the remote handset. On these products the balance will automatically centre as it reaches the mid point. Centring is indicated by a flashing volume control indicator. To resume adjustment once the balance has centred, the **bal** key must be released and re-pressed.
- mon** Enables the output of a tape recorder to be heard while recording. The source to be recorded is chosen by the input selection buttons in the normal way. A second operation of the mon key restores normal operation. Mon alternatively operates the mono function on appropriately equipped preamplifiers.

Preamplifier and Integrated Amplifier **Soft Keys** operate as follows:

- disp** Switches the front panel button indicators off and on.
- prog** Press and hold to switch the preamplifier or integrated amplifier into program mode.
- numeric** Enables direct selection of source inputs.

30.2 NARCOM 4 Keys

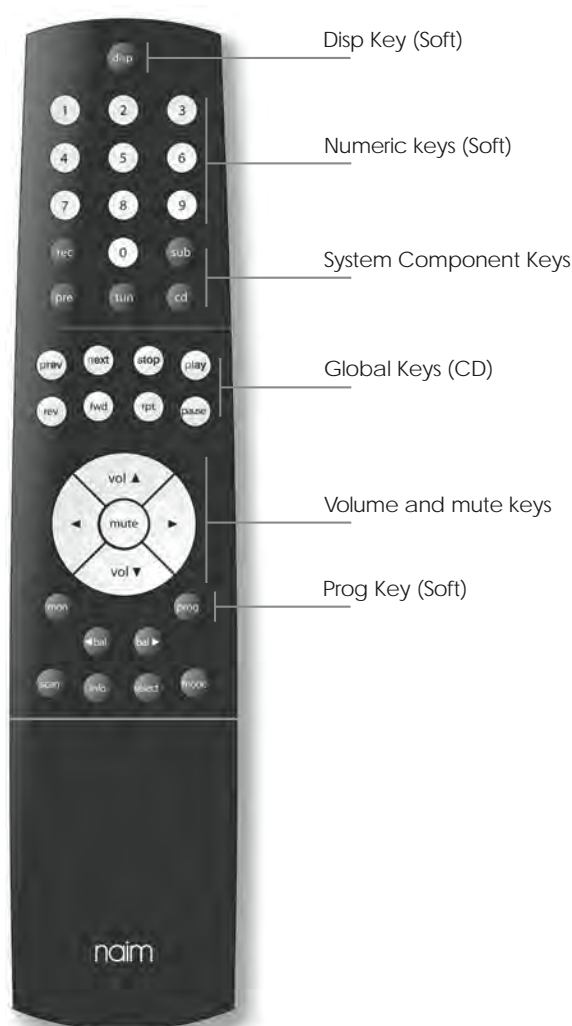

NAP 500 Power Amplifier

31 Installation and Operation

The NAP 500 and NAP 500PS should be installed on a dedicated equipment stand intended for the purpose and should be in their final location before connecting cables or switching on. Switch on the source and preamplifier components, with the volume turned down, before switching on the NAP 500. The NAP 500 power button is located on the front panel of the NAP 500PS Power Supply.

Care should be taken when siting the NAP 500 to ensure that the top and bottom ventilation grids are not blocked.

The NAP 500 and NAP 500PS are very heavy and care should be taken when lifting or moving them. Make sure that the surface they are to be placed on can support the full weight.

31.1 General Connections Notes

The negative input and output connections for each channel are common. The mains earth (ground) should always be connected regardless of what other equipment is used in conjunction with Naim power amplifiers. This only grounds the case and the electrostatic screen within the transformer, and is not connected to the signal negative. In order to avoid hum loops, the signal negative of the whole system should be connected to the mains earth (ground) in one place.

Note: *Each channel of the NAP 500 is a "bridged" amplifier, so none of the speaker outlet sockets (+ or -) is at earth potential. Avoid connecting mains powered equipment such as electrostatic speakers, sub-woofers and headphone energisers that do not have a floating earth. No plug which is connected directly or indirectly to earth potential should be attached to any speaker outlet (+ or -).*

31.2 Protection Notes

In the NAP 500 the fan speed is increased in response to an increase in amplifier dissipation. If the amplifier reaches 70°C due to prolonged running at high level or to airflow being blocked, the output will be interrupted and the fan will run at full speed until it has cooled down. This may take a few minutes.

It is not necessary to switch the amplifier off, but it may be advisable to mute the preamplifier or turn the volume down to avoid surprises when it comes back on.

OPERATION OF THE AMPLIFIER'S THERMAL PROTECTION SUGGESTS PROLONGED USE AT TOO HIGH A VOLUME LEVEL. YOUR LOUDSPEAKERS MAY BE AT RISK IF THIS IS THE CASE. THE VOLUME SHOULD BE REDUCED.

31.3 Loudspeaker Cable and Connectors

Only Naim Audio speaker cable should be used to connect a loudspeaker to the output of the NAP 500. Custom Naim Audio loudspeaker connectors are supplied to make the connection and in order to comply with current European safety regulations these should always be used.

DAMAGE TO THE AMPLIFIER MAY RESULT IF "HIGH DEFINITION" CABLE OR ANY OTHER SPECIAL CABLE IS USED TO CONNECT THE LOUDSPEAKERS.

Ensure when connecting speakers that they are "in phase". That is, the positive and negative connection orientation at both the speaker and amplifier ends of the cable is the same for both channels.

NAP 500 Power Amplifier

32 NAP 500 Connections

32.1 NAP 500 Connected to NAP 500PS

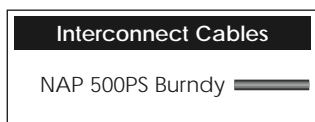
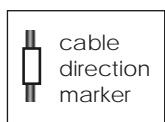
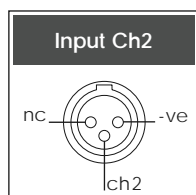
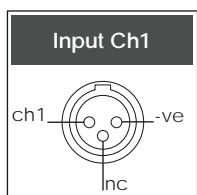
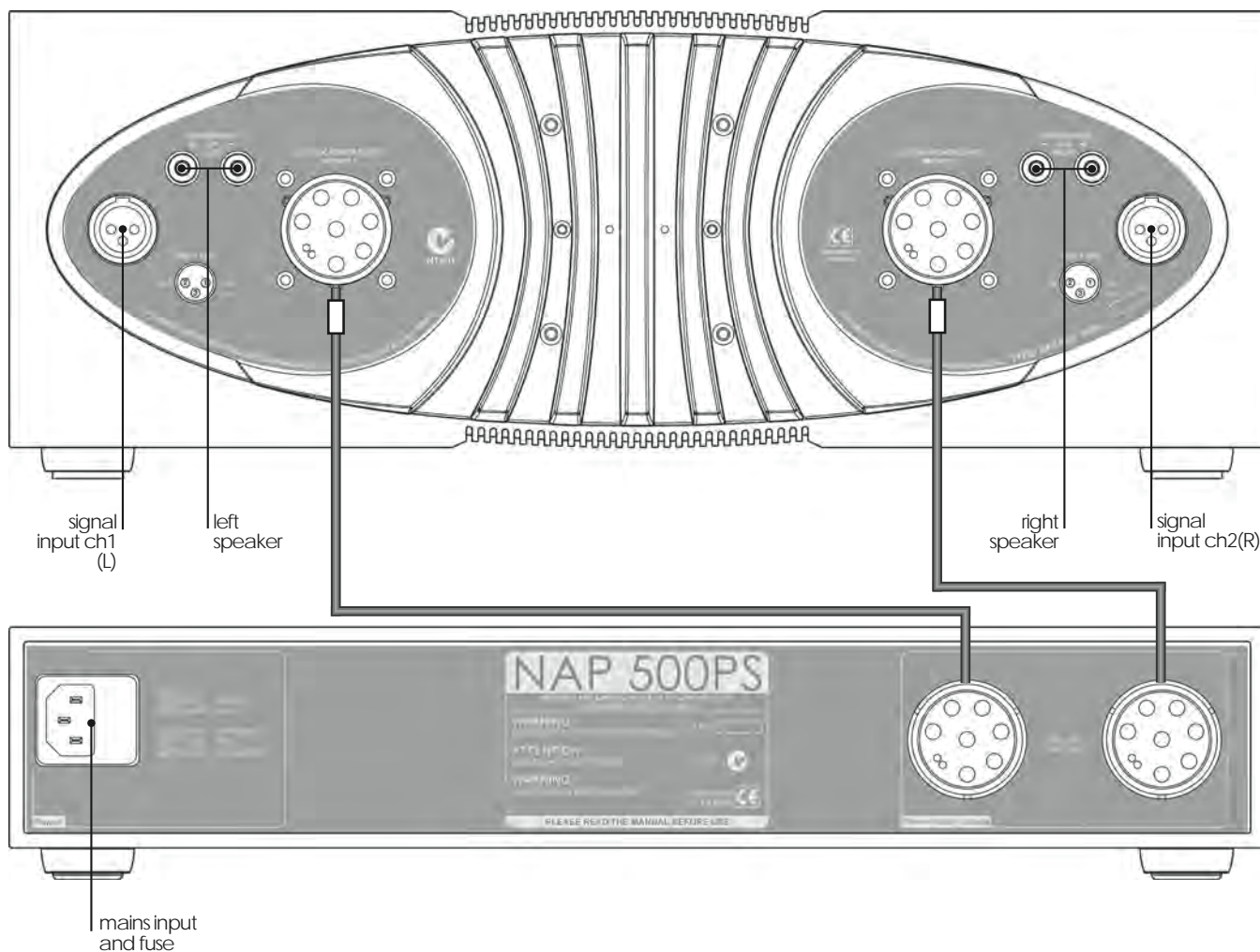

33 NAP 500/NAP 500PS Specification

Power Output:	140 Watts per channel, 8Ω 700 VA Transient
Quiescent Consumption:	60VA
Voltage Gain:	+29dB
Input Impedance:	18kΩ
Frequency Response:	-3dB @ 1.5Hz and 100kHz
Dimensions (H x W x D):	NAP 500 - 160 x 432 x 375mm NAP 500PS - 87 x 432 x 314mm
Weights:	NAP 500 - 25kg NAP 500PS - 15.4kg
Mains Supply (NAP 500PS):	100-120V or 220-240V, 50/60Hz

NAP 300 Power Amplifier

34 Installation and Operation

The NAP 300 and NAP 300PS should be installed on a dedicated equipment stand intended for the purpose and should be in their final location before connecting cables or switching on. Switch on the source and preamplifier components, with the volume turned down, before switching on the NAP 300. The NAP 300 power button is located on the front panel of the NAP 300PS Power Supply.

Care should be taken when siting the NAP 300 to ensure that the underside fan inlet and rear outlet are not obstructed.

The NAP 300 and NAP 300PS are heavy and care should be taken when lifting or moving them. Make sure that the surface they are to be placed on can support the full weight.

34.1 General Connections Notes

The negative input and output connections for each channel are common. The mains earth (ground) should always be connected regardless of what other equipment is used in conjunction with Naim power amplifiers. This only grounds the case and the electrostatic screen within the transformer, and is not connected to the signal negative. In order to avoid hum loops, the signal negative of the whole system should be connected to the mains earth (ground) in one place.

34.2 Protection Notes

In the NAP 300 the fan speed is increased in response to an increase in amplifier dissipation. If the amplifier reaches 70°C due to prolonged running at high level or to airflow being blocked, the output will be interrupted and the fan will run at full speed until it has cooled down. This may take a few minutes.

It is not necessary to switch the amplifier off, but it may be advisable to mute the preamplifier or turn the volume down to avoid surprises when it comes back on.

OPERATION OF THE AMPLIFIER'S THERMAL PROTECTION SUGGESTS PROLONGED USE AT TOO HIGH A VOLUME LEVEL. YOUR LOUDSPEAKERS MAY BE AT RISK IF THIS IS THE CASE. THE VOLUME SHOULD BE REDUCED.

34.3 Loudspeaker Cable and Connectors

Only Naim Audio speaker cable should be used to connect a loudspeaker to the output of the NAP 300. Custom Naim Audio loudspeaker connectors are supplied to make the connection and in order to comply with current European safety regulations these should always be used.

DAMAGE TO THE AMPLIFIER MAY RESULT IF "HIGH DEFINITION" CABLE OR ANY OTHER SPECIAL CABLE IS USED TO CONNECT THE LOUDSPEAKERS.

Ensure when connecting speakers that they are "in phase". That is, the positive and negative connection orientation at both the speaker and amplifier ends of the cable is the same for both channels.

NAP 300 Power Amplifier

35 NAP 300 Connections

35.1 NAP 300 Connected to NAP 300PS

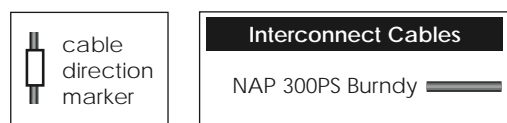
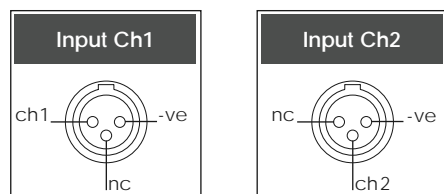
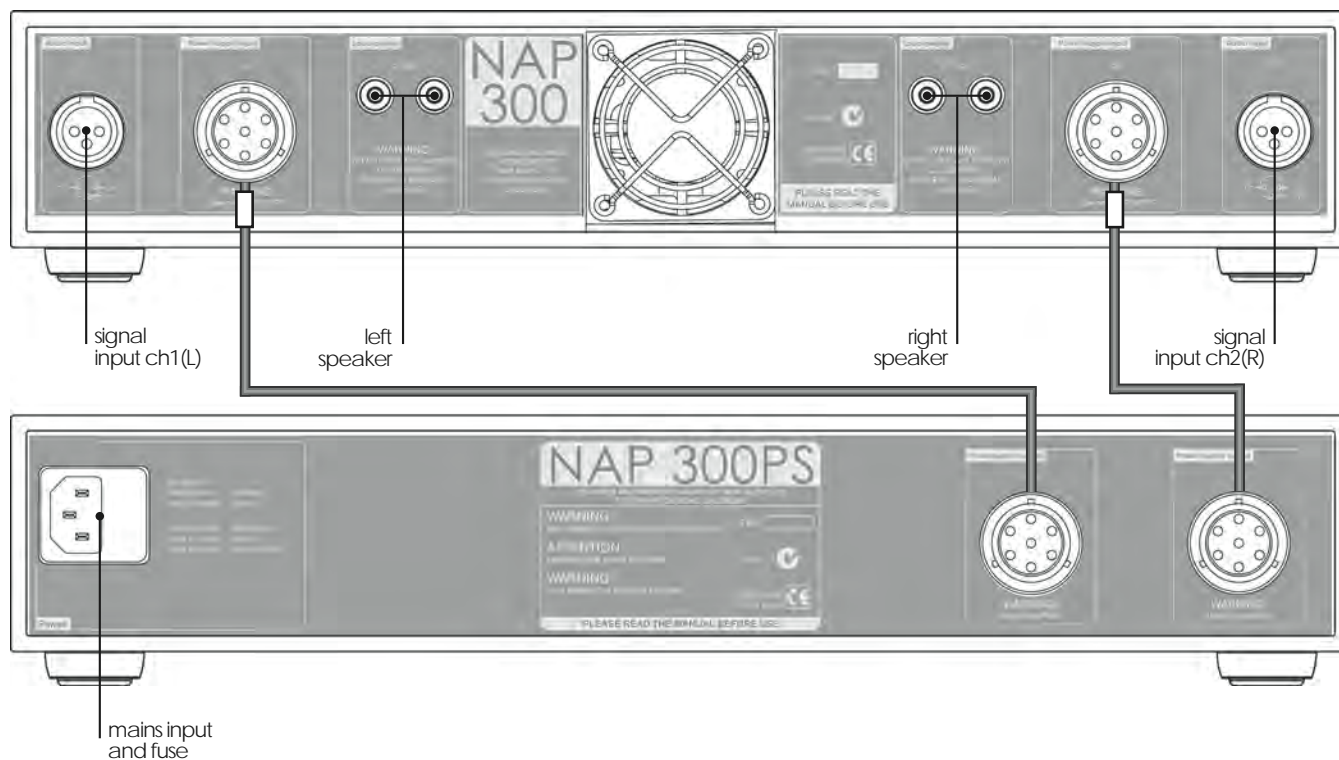

36 NAP 300/NAP 300PS Specification

Power Output:	90 Watts per channel, 8Ω 500 VA Transient
Quiescent Consumption:	27VA
Voltage Gain:	+29dB
Input Impedance:	18kΩ
Frequency Response:	-3dB @ 2Hz and 70kHz
Dimensions (H x W x D):	Both - 87 x 432 x 314mm
Weights:	NAP 300 - 10.7kg NAP 300PS - 14.1kg
Mains Supply (NAP 300PS):	100-120V or 220-240V, 50/60Hz

NAP 250 Power Amplifier

37 Installation and Operation

The NAP 250 should be installed on a dedicated equipment stand intended for the purpose and should be in its final location before connecting cables or switching on. Switch on the source and preamplifier components, with the volume turned down, before switching on the NAP 250. The NAP 250 power button is located on the front panel.

The NAP 250 is heavy and care should be taken when lifting or moving it. Make sure that the surface it is to be placed on can support the full weight.

37.1 General Connections Notes

The negative input and output connections are all common. The mains earth should always be connected regardless of what other equipment is used. This only grounds the case and the electrostatic screen within the transformer, and is not connected to the signal negative. In order to avoid hum loops, the signal negative of the whole system should be connected to the mains earth (ground) in one place.

37.2 Protection Notes

If the amplifier's external case reaches 70°C due to prolonged running at high power, the mains supply will be interrupted and the illuminated logo will switch off until the amplifier has cooled down. This may take up to thirty minutes.

38 NAP 250 Connections

38.1 NAP 250 Rear



39 NAP 250 Specification

Power Output:	80 Watts per channel, 8Ω 400 VA Transient
Quiescent Consumption:	25VA
Voltage Gain:	+29dB
Input Impedance:	18kΩ
Frequency Response:	-3dB @ 2Hz and 65kHz
Dimensions (H x W x D):	87 x 432 x 314mm
Weight	15.8kg
Mains Supply:	100-120V or 220-240V, 50/60Hz

OPERATION OF THE AMPLIFIER'S THERMAL PROTECTION SUGGESTS PROLONGED USE AT TOO HIGH A VOLUME LEVEL. YOUR LOUDSPEAKERS MAY BE AT RISK IF THIS IS THE CASE. THE VOLUME SHOULD BE REDUCED.

37.3 Loudspeaker Cable and Connectors

Only Naim Audio speaker cable should be used to connect a loudspeaker to the output of the NAP 250. Custom Naim Audio loudspeaker connectors are supplied to make the connection and in order to comply with current European safety regulations these should always be used.

DAMAGE TO THE AMPLIFIER MAY RESULT IF "HIGH DEFINITION" CABLE OR ANY OTHER SPECIAL CABLE IS USED TO CONNECT THE LOUDSPEAKERS.

Ensure when connecting speakers that they are "in phase". That is, the positive and negative connection orientation at both the speaker and amplifier ends of the cable is the same for both channels.

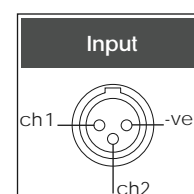

NAPV 145 Power Amplifier

40 Installation and Operation

The NAPV 145 is a mono power amplifier intended for use in audio-visual systems. The NAPV 145 should be installed on a dedicated equipment stand intended for the purpose and should be in its final location before connecting cables or switching on. Switch on the source and preamplifier components, with the volume turned down, before switching on the NAPV 145. The NAPV 145 power button is located on the front panel.

The NAPV 145 is heavy and care should be taken when lifting or moving it. Make sure that the surface it is to be placed on can support the full weight.

40.1 General Connections Notes

The negative input and output connections are all common. The mains earth should always be connected regardless of what other equipment is used. This only grounds the case and the electrostatic screen within the transformer, and is not connected to the signal negative. In order to avoid hum loops, the signal negative of the whole system should be connected to the mains earth (ground) in one place.

40.2 Protection Notes

If the amplifier's external case reaches 70°C due to prolonged running at high power, the mains supply will be interrupted and the illuminated logo will switch off until the amplifier has cooled down. This may take up to thirty minutes.

41 NAPV 145 Connections

41.1 NAPV 145 Rear



OPERATION OF THE AMPLIFIER'S THERMAL PROTECTION SUGGESTS PROLONGED USE AT TOO HIGH A VOLUME LEVEL. YOUR LOUDSPEAKERS MAY BE AT RISK IF THIS IS THE CASE. THE VOLUME SHOULD BE REDUCED.

40.3 Loudspeaker Cable and Connectors

Only Naim Audio speaker cable should be used to connect a loudspeaker to the output of the NAPV 145. Custom Naim Audio loudspeaker connectors are supplied to make the connection and in order to comply with current European safety regulations these should always be used.

DAMAGE TO THE AMPLIFIER MAY RESULT IF "HIGH DEFINITION" CABLE OR ANY OTHER SPECIAL CABLE IS USED TO CONNECT THE LOUDSPEAKERS.

Ensure when connecting speakers that they are "in phase". That is, the positive and negative connection orientation at both the speaker and amplifier ends of the cable is the same for both channels.

42 NAPV 145 Specification

Power Output:	80 Watts, 8Ω 400 VA Transient
Quiescent Consumption:	15VA
Voltage Gain:	+29dB
Input Impedance:	18kΩ
Frequency Response:	-3dB @ 2Hz and 65kHz
Dimensions (H x W x D):	87 x 432 x 314mm
Weight	15.8kg
Mains Supply:	100-120V or 220-240V, 50/60Hz

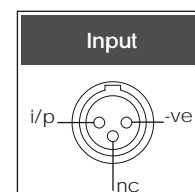

NAP 200 Power Amplifier

43 Installation and Operation

The NAP 200 should be installed on a dedicated equipment stand intended for the purpose and should be in its final location before connecting cables or switching on. Switch on the source and preamplifier components, with the volume turned down, before switching on the NAP 200. The NAP 200 power button is located on the front panel.

The NAP 200 can provide power for an appropriate Naim Audio preamplifier. The power supply output is carried on the DIN input socket.

The NAP 200 is heavy and care should be taken when lifting or moving it. Make sure that the surface it is to be placed on can support its full weight.

43.1 General Connections Notes

The negative input and output connections are all common. The mains earth should always be connected regardless of what other equipment is used. This only grounds the case and the electrostatic screen within the transformer, and is not connected to the signal negative. In order to avoid hum loops, the signal negative of the whole system should be connected to the mains earth (ground) in one place.

43.2 Protection Notes

If the amplifier's external case reaches 70°C due to prolonged running at high power, the mains supply will be interrupted and the illuminated logo will switch off until the amplifier has cooled down. This may take up to thirty minutes.

OPERATION OF THE AMPLIFIER'S THERMAL PROTECTION SUGGESTS PROLONGED USE AT TOO HIGH A VOLUME LEVEL. YOUR LOUDSPEAKERS MAY BE AT RISK IF THIS IS THE CASE. THE VOLUME SHOULD BE REDUCED.

43.3 Loudspeaker Cable and Connectors

Only Naim Audio speaker cable should be used to connect a loudspeaker to the output of the NAP 200. Custom Naim Audio loudspeaker connectors are supplied to make the connection and in order to comply with current European safety regulations these should always be used.

DAMAGE TO THE AMPLIFIER MAY RESULT IF "HIGH DEFINITION" CABLE OR ANY OTHER SPECIAL CABLE IS USED TO CONNECT THE LOUDSPEAKERS.

Ensure when connecting speakers that they are "in phase". That is, the positive and negative connection orientation at both the speaker and amplifier ends of the cable is the same for both channels.

44 NAP 200 Connections

44.1 NAP 200 Rear



45 NAP 200 Specification

Power Output:	70 Watts per channel, 8Ω 300 VA Transient
Quiescent Consumption:	11VA
Voltage Gain:	+29dB
Input Impedance:	18kΩ
Frequency Response:	-3dB @ 2Hz and 65kHz
Power Supply Output:	24V, 0.3A
Dimensions (H x W x D):	87 x 432 x 314mm
Weight	11.6kg
Mains Supply:	100-120V or 220-240V, 50/60Hz

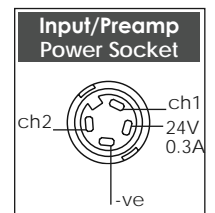

NAP 155 XS Power Amplifier

46 Installation and Operation

The NAP 155 XS should be installed on a dedicated equipment stand intended for the purpose and should be in its final location before connecting cables or switching on. Switch on the source and preamplifier components, with the volume turned down, before switching on the NAP 155 XS. The NAP 155 XS power switch is located on the rear panel.

The NAP 155 XS can provide power for an appropriate Naim Audio preamplifier. The power supply output is carried on the DIN input socket.

46.1 General Connections Notes

The negative input and output connections are all common. The mains earth should always be connected regardless of what other equipment is used. This only grounds the case and the electrostatic screen within the transformer, and is not connected to the signal negative. In order to avoid hum loops, the signal negative of the whole system should be connected to the mains earth (ground) in one place.

46.2 Protection Notes

If the amplifier's external case reaches 70°C due to prolonged running at high power, the mains supply will be interrupted and the illuminated logo will switch off until the amplifier has cooled down. This may take up to thirty minutes.

OPERATION OF THE AMPLIFIER'S THERMAL PROTECTION SUGGESTS PROLONGED USE AT TOO HIGH A VOLUME LEVEL. YOUR LOUDSPEAKERS MAY BE AT RISK IF THIS IS THE CASE. THE VOLUME SHOULD BE REDUCED.

46.3 Loudspeaker Cable and Connectors

Only Naim Audio speaker cable should be used to connect a loudspeaker to the output of the NAP 155 XS. Custom Naim Audio loudspeaker connectors are supplied to make the connection and in order to comply with current European safety regulations these should always be used.

DAMAGE TO THE AMPLIFIER MAY RESULT IF "HIGH DEFINITION" CABLE OR ANY OTHER SPECIAL CABLE IS USED TO CONNECT THE LOUDSPEAKERS.

Ensure when connecting speakers that they are "in phase". That is, the positive and negative connection orientation at both the speaker and amplifier ends of the cable is the same for both channels.

47 NAP 155 XS Connections

47.1 NAP 155 XS Rear



48 NAP 155 XS Specification

Power Output:	60 Watts per channel, 8Ω 250 VA Transient
Quiescent Consumption:	10VA
Voltage Gain:	+29dB
Input Impedance:	18kΩ
Frequency Response:	-3dB @ 3Hz and 50kHz
Power Supply Output:	24V, 0.25A
Dimensions (H x W x D):	70 x 432 x 301mm
Weight	7.5kg
Mains Supply:	100-120V or 220-240V, 50/60Hz

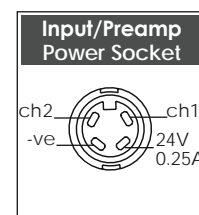

Note: The NAP 155 XS features various technologies to reduce microphonic effects. Some movement of the board and sockets when connecting and disconnecting cables is normal.

NAPV 175 Power Amplifier

49 Installation and Operation

The NAPV 175 is a three channel power amplifier intended for use in audio-visual systems. The three channels provide power to drive a centre channel speaker and a pair of either main front or surround channel speakers. Audio line level input is via two 4-pin DIN sockets - one for the centre channel and one for the main or surround pair.

The NAPV 175 should be installed on an equipment rack intended for the purpose and in its final location before connecting cables or switching on. Switch on the source and preamplifier components, with the volume turned down, before switching on the NAPV 175. The power switch is located on the rear panel.

The NAPV 175 is heavy and care should be taken when lifting or moving it. Make sure that the surface it is to be placed on can support the full weight.

49.1 General Connections Notes

The mains earth grounds only the case and the electrostatic screen within the transformer and is not connected to the signal negative. The mains earth must always be connected to "ground" regardless of any other equipment used. In order to avoid hum-loops the signal negative of the whole system should be connected to the mains earth in one place.

49.2 Protection Notes

Once installed the NAP V175 is intended to remain permanently powered up via its rear panel switch. If the internal heatsink reaches 70°C due to prolonged running at very high dissipation the mains supply will be interrupted and the illuminated logo will go off until the amplifier has cooled down. This may take up to thirty minutes.

OPERATION OF THE AMPLIFIER'S THERMAL PROTECTION SUGGESTS PROLONGED USE AT TOO HIGH A VOLUME LEVEL. YOUR LOUDSPEAKERS MAY BE AT RISK IF THIS IS THE CASE. THE VOLUME SHOULD BE REDUCED.

49.3 Loudspeaker Cable and Connectors

Only Naim Audio speaker cable should be used to connect a loudspeaker to the output of the NAPV 175. Custom Naim Audio loudspeaker connectors are supplied to make the connection and in order to comply with current European safety regulations these should always be used.

DAMAGE TO THE AMPLIFIER MAY RESULT IF "HIGH DEFINITION" CABLE OR ANY OTHER SPECIAL CABLE IS USED TO CONNECT THE LOUDSPEAKERS.

Ensure when connecting speakers that they are "in phase". That is, the positive and negative connection orientation at both the speaker and amplifier ends of the cable is the same for all channels.

50 NAPV 175 Connections

50.1 NAPV 175 Rear



51 NAPV 175 Specification

Power Output:	50 Watts per channel, 8Ω
Channels:	Three
Quiescent Consumption:	10VA
Voltage Gain:	+29dB
Input Impedance:	18kΩ
Frequency Response:	-3dB @ 3Hz and 50kHz
Dimensions (H x W x D):	70 x 432 x 301mm
Weight	7.9kg
Mains Supply:	100-120V or 220-240V, 50/60Hz

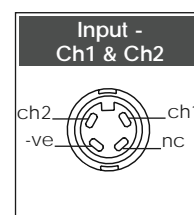
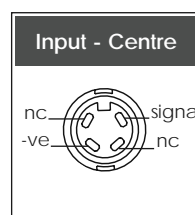

Declarations of Conformity

52 Declaration of Conformity

Manufacturer	Naim Audio Limited, Southampton Road, Salisbury, England, SP1 2LN
Products	Preamplifiers - NAC 552, NAC 252, NAC 282, NAC 202, NAC 152 XS Integrated Amplifiers - SuperNait, NAIT XS, NAIT 5i Power Amplifiers - NAP 500/NAP 500PS, NAP 300/NAP 300PS, NAP 250, NAPV 145, NAP 200, NAP 155 XS, NAPV 175,
Safety	EN 60065
Safety	EN 60065 - Audio video and similar electronic apparatus. Safety requirements.
EMC	EN 55013 - Sound and television broadcast receivers and associated equipment. EN55020 - Electromagnetic immunity of broadcast receivers and associated equipment. EN 61000-3-2 - Limits for harmonic current emissions. EN 61000-4-2 - Testing and measurement. Electrostatic discharge immunity.

Naim Audio Ltd, Southampton Road, Salisbury, England SP1 2LN
Tel: +44 (0) 1722 426600 Fax: +44 (0)871 230 1012
W: www.naimaudio.com
Part No. 12-001-0041 Iss. 5

Products that display the crossed-out wheeled bin logo cannot be disposed of as domestic waste. These products must be disposed of at facilities capable of re-cycling them and appropriately handling any waste by-products. Contact your local authority for details of the nearest such facility. Appropriate recycling and waste disposal helps conserve resources and protects the environment from contamination.

