

ST6

SOLO6 - TWIN6 - TRIO6 - SUB12

Démarrage rapide / Quick Start

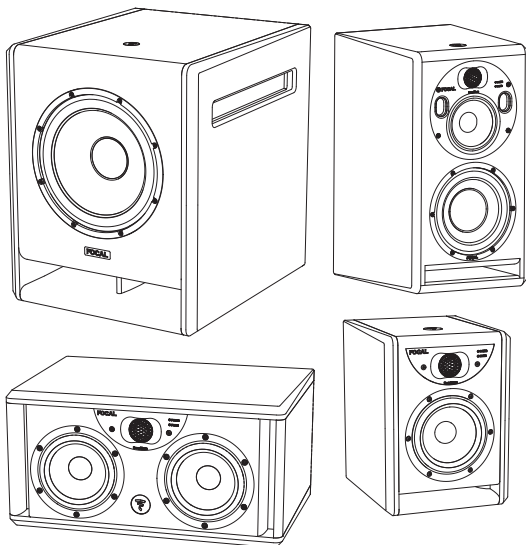

GO TO THE
USER MANUAL



[www.focal.com/
ST6/usermanual](http://www.focal.com/ST6/usermanual)

- FR** Accéder à la notice d'utilisation
- DE** Bedienungsanleitung lesen
- ES** Acceda a las instrucciones de uso
- IT** Accedi alle istruzioni per l'uso
- PT** Ir para o manual do utilizador
- NL** Ga naar de gebruiksaanwijzing
- PL** Przejdź do instrukcji obsługi
- RU** Перейти к инструкции по эксплуатации
- ZH** 访问使用说明
- KO** 사용설명서 보러가기
- JP** 取扱説明書を見る
- AR** اذهب إلى دليل الاستخدام

SOLO6

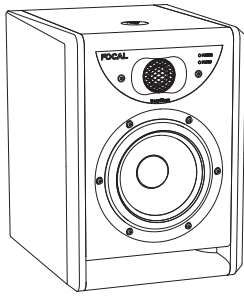

A

x 1

TWING

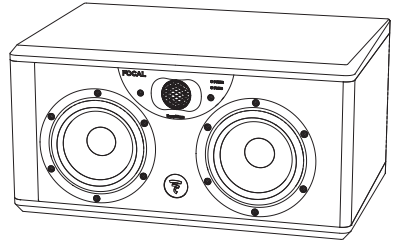

A

x 1

SUB12

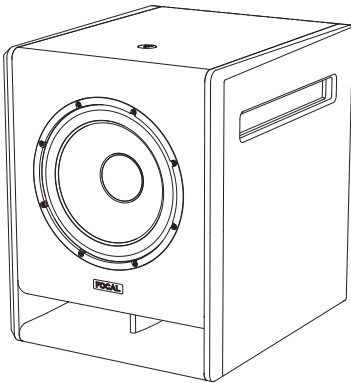

A

x 1

TRIO6

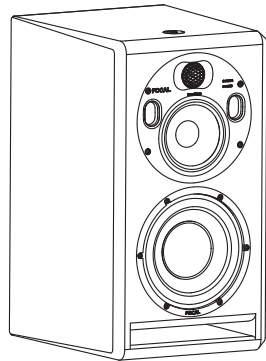

A

x 1

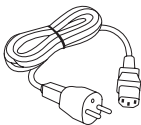

B

x 1



C

x 4



D

x 1

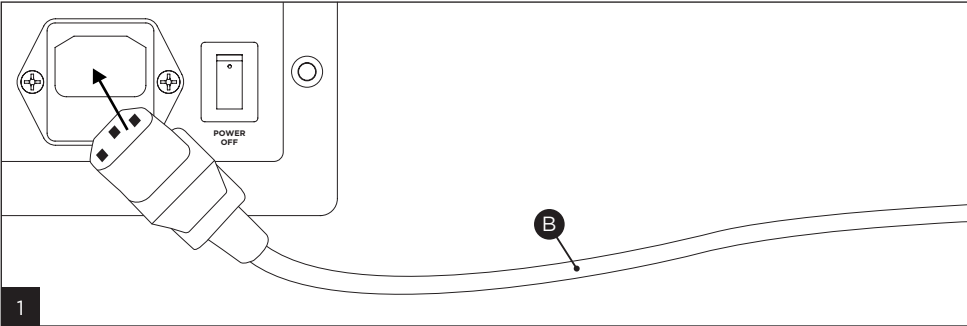

SOLO6

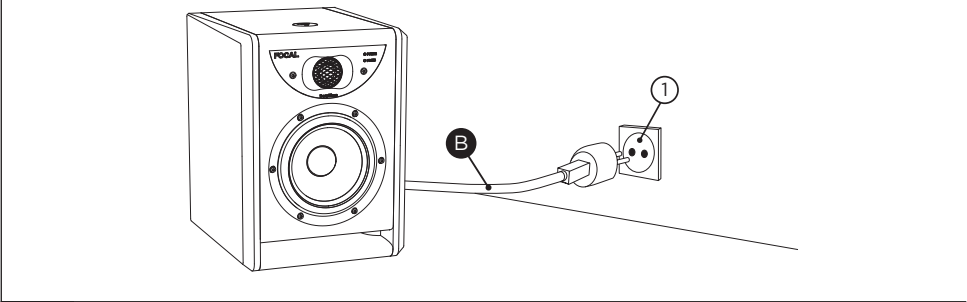

TWIN6

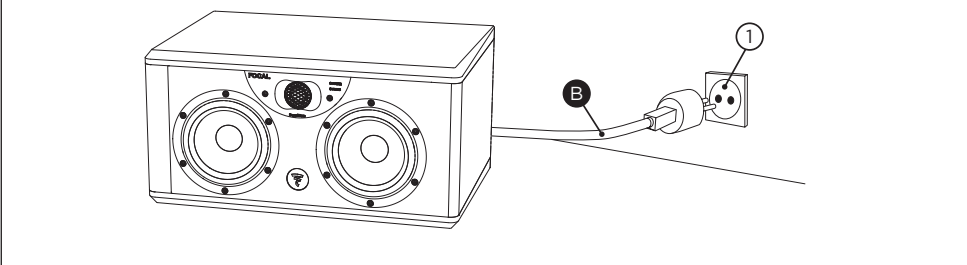

SUB12

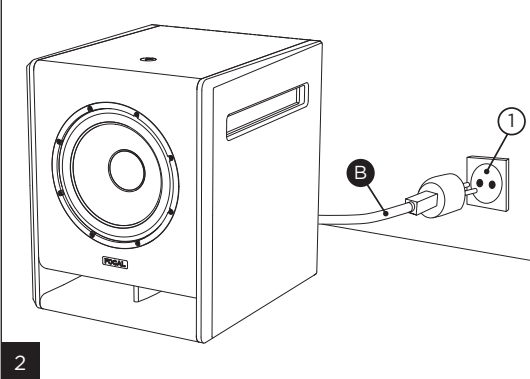

TRIO6

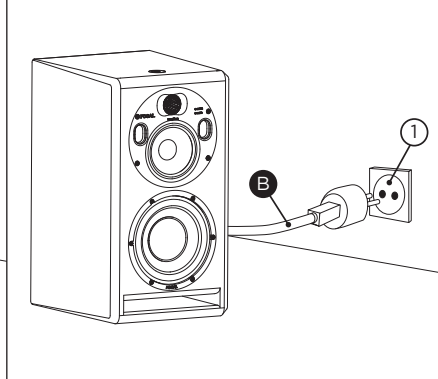

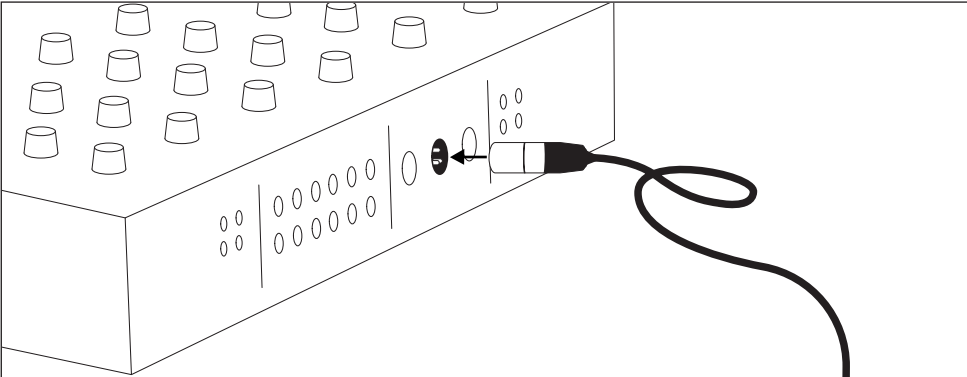

SOLO6

TRIO6

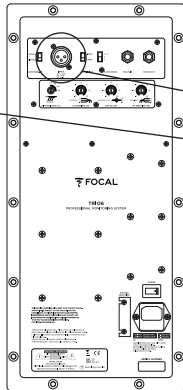
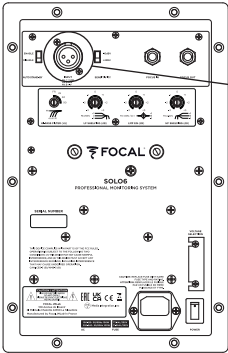
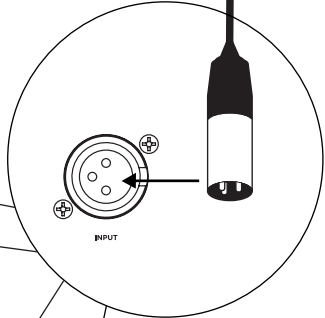

TWIN6

SUB12

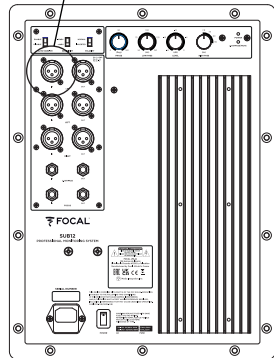
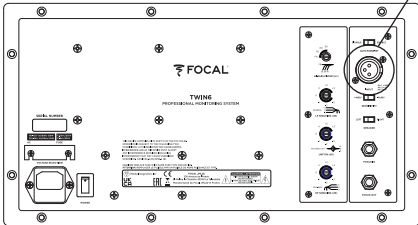

SOLO6

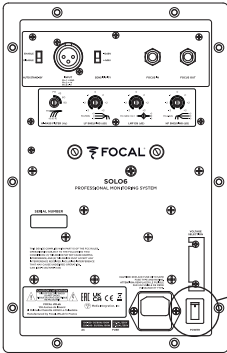

TRIO6

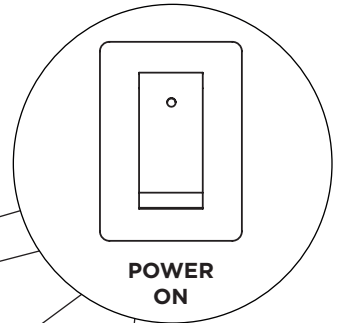
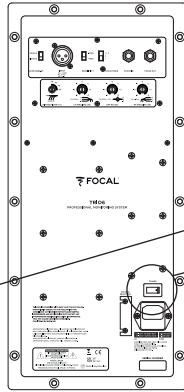

TWIN6

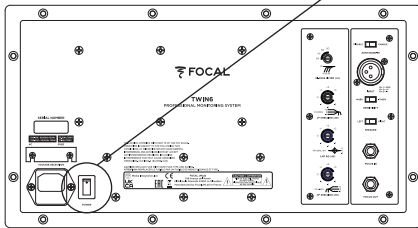



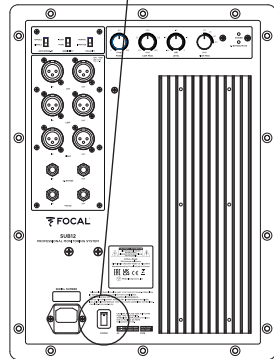



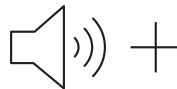
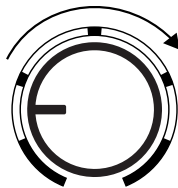



































































SUB12























































































































































































4



5

	<div style="text-align: center; border: 1px solid black; padding: 5px; background-color: #f0f0f0;"> <p>CAUTION RISK OF ELECTRIC SHOCK DO NOT OPEN</p> </div>	
<p>L'éclair représenté par le symbole flèche et contenu dans un triangle équilatéral, a pour but de prévenir l'utilisateur de la présence de tension élevée au sein de l'appareil pouvant entraîner un choc électrique.</p>	<p>ATTENTION : Afin de prévenir tout choc électrique, ne pas retirer le capot (ou l'arrière) de cet appareil. Aucune pièce n'est remplaçable par l'utilisateur. Si un entretien ou une réparation de l'appareil est nécessaire, contacter une personne qualifiée.</p>	<p>Symbole de mise en garde. Ce symbole est destiné à prévenir l'utilisateur de la présence d'instructions importantes mentionnées dans le manuel d'utilisation et relatives à la manipulation, mise en œuvre et à l'entretien de l'appareil.</p>
<div style="display: flex; flex-direction: column; gap: 10px;">                               </div>	<div style="display: flex; flex-direction: column; gap: 10px;">             </div> <p>de votre produit, votre installateur ou votre fournisseur d'électricité. Pour les appareils prévus pour une utilisation à partir d'une batterie ou d'une autre source d'alimentation, se référer au manuel d'utilisation.</p> <p>16. Ce produit appartient aux appareils de Classe I. Connecter l'appareil uniquement à l'aide de la fiche secteur fournie intégrant une liaison à la terre. L'appareil doit être raccordé à une prise secteur dotée d'une protection par mise à la terre.</p> <p>17. Si la fiche secteur ou un connecteur est utilisé(e) comme dispositif de débranchement de l'appareil, celui-ci doit être facilement accessible. Pour débrancher l'appareil du secteur, retirez la fiche secteur de la prise de courant.</p> <p>18. Ne pas surcharger les prises murales, les rallonges électriques ou les prises multiples. Il pourrait en résulter incendies ou chocs électriques. Veiller à ne pas dépasser la puissance maximale admissible de chaque élément de l'installation.</p> <p>19. ATTENTION : pour réduire le risque d'incendie ou de choc électrique, ne pas exposer cet appareil à l'eau, la pluie ou à l'humidité. De plus, l'appareil ne doit pas être exposé à des écoulements d'eau ou des éclaboussures et aucun objet rempli de liquide, tel qu'un vase, ne doit être posé sur l'appareil.</p> <p>20. Ne jamais insérer d'objets par les trous de ventilation de l'appareil. Ils pourraient entrer en contact avec les composants soumis à de hautes tensions ou les court-circuiter et ainsi occasionner un incendie ou un choc électrique.</p> <p>21. La température ambiante lors de l'utilisation de l'appareil ne doit pas dépasser 35 degrés Celsius (95°F).</p> <p>22. Ne pas utiliser cet appareil dans des climats tropicaux.</p> <p>23. Ne pas utiliser cet appareil dans des zones situées au-dessus de 2000 m d'altitude.</p> <p>24. Si l'appareil a été transporté d'un environnement froid à un environnement chaud, s'assurer qu'aucun phénomène de condensation ne s'est produit avant de connecter le cordon d'alimentation.</p> <p>25. Toujours laisser une distance de 5 cm (2") minimum autour du produit pour assurer une bonne ventilation.</p> <p>26. Ne pas approcher de l'appareil une source de flammes nues, telle que des bougies allumées.</p>	<div style="display: flex; flex-direction: column; gap: 10px;">                                </div> <p>27. L'appareil ne doit être monté sur un mur ou au plafond que si le constructeur le prévoit.</p> <p>28. Ce produit présente des angles vifs. Le manipuler avec précaution.</p> <p>29. Ne pas tenter de réparer cet appareil par vos propres moyens. L'ouverture de cet appareil peut s'avérer dangereuse. Pour toute intervention sur l'appareil, s'adresser à un personnel qualifié.</p> <p>30. Lorsque le remplacement de composants est nécessaire, n'utiliser que les composants spécifiés par le fabricant ou présentant des caractéristiques identiques à l'exemple d'origine. Des composants non-conformes peuvent provoquer incendies, chocs électriques ou autres risques.</p> <p>31. Après toute intervention ou réparation sur l'appareil, procéder à des tests afin de vérifier que le produit fonctionne en toute sécurité.</p> <p>32. Mettre le volume de la source au minimum avant d'y raccorder les produits et d'augmenter le volume. Une fois les produits en place, augmenter progressivement le volume jusqu'à un niveau raisonnable et agréable.</p> <p>33. Afin d'éviter des dommages auditifs éventuels, ne pas écouter les enceintes à un niveau sonore élevé pendant une longue durée. L'écoute d'enceintes à un niveau sonore excessif peut endommager l'oreille de l'utilisateur et entraîner des troubles auditifs (surdité temporaire ou définitive, bourdonnements d'oreille, acouphènes, hyperacousie). L'exposition de l'appareil auditif à un niveau supérieur à 85 dB SPL LAeq pendant plusieurs heures peut endommager l'ouïe irréversiblement.</p> <p>34. Après avoir déballe le produit, veiller à ne pas laisser l'emballage à portée des enfants. Il présente un risque de suffocation.</p> <p>35. Certains utilisateurs ne disposent pas d'une autonomie suffisante pour utiliser seuls le produit sans danger. En particulier, les enfants âgés de moins de 14 ans et les personnes présentant certaines déficiences doivent être impérativement surveillés et accompagnés lors de l'utilisation de l'appareil.</p> <p>Canada : Industry Canada Statement Le présent appareil est conforme aux CNR d'ISED applicables aux appareils radio exempts de licence. L'exploitation est autorisée aux deux conditions suivantes : (1) le dispositif ne doit pas produire de brouillage préjudiciable, et (2) ce dispositif doit accepter tout brouillage reçu, y compris un brouillage susceptible de provoquer un fonctionnement indésirable.</p>



	<div style="text-align: center; border: 1px solid black; padding: 5px;"> <p>CAUTION</p> <p>RISK OF ELECTRIC SHOCK DO NOT OPEN</p> </div>	
<p>The bolt of lightning in an equilateral triangle warns the user that the device has high voltage that could result in a risk of electric shock.</p>	<p>WARNING: To prevent any risk of electric shock, do not remove the cover (or the back) from the device. There are no user-serviceable parts in this device. For maintenance or repairs, contact a qualified professional.</p>	<p>Warning symbol. This symbol is designed to warn the user of the presence of important instructions mentioned in the user manual and relating to the handling, operation and maintenance of the device.</p>
<div style="display: flex; flex-direction: row-reverse;"> <div style="margin-right: 10px;">                               </div> <div> <p>1. Read these instructions.</p> <p>2. Keep these instructions.</p> <p>3. Heed all warnings.</p> <p>4. Follow all instructions.</p> <p>5. Do not use this apparatus near water.</p> <p>6. Clean only with dry cloth.</p> <p>7. Do not block any ventilation openings. Install in accordance with the manufacturer's instructions.</p> <p>8. Do not install near any heat sources such as radiators, heat registers, stoves, or other apparatus (including amplifiers) that produce heat.</p> <p>9. Do not defeat the safety purpose of the polarized plug (common). A polarized plug has two blades with one wider than the other. The wide bladed is provided for your safety. If the provided plug does not fit into your outlet, consult an electrician for replacement of the obsolete outlet.</p> <p>10. Protect the power cord from being walked on or pinched particularly at plugs, convenience receptacles, and the point where they exit from the apparatus.</p> <p>11. Only use attachments/accessories specified by the manufacturer.</p> <p>12. Use only with the cart, stand, tripod, bracket, or table specified by the manufacturer, or sold with the apparatus. When a cart is used, use caution when moving the cart/apparatus combination to avoid injury from tip-over.</p> <p>13. Unplug this apparatus during lightning storms or when unused for long periods of time.</p> <p>14. Refer all servicing to qualified service personnel. Servicing is required when the apparatus has been damaged in any way, such as power-supply cord or plug is damaged, liquid has been spilled or objects have fallen into the apparatus, the apparatus has been exposed to rain or moisture, does not operate normally, or has been dropped.</p> <p>15. Only connect this product to the type of mains electrical supply indicated on the device. If you are unsure what type of mains electrical supply is required for the product or your electrical installation, ask your installer or your electricity supplier. For devices intended for use with a battery or another power source, see the user manual.</p> <p>16. This product is a Class 1 appliance. Only plug in the device using the mains plug provided, which incorporates an earth connection. The device must be plugged into an earthed mains socket.</p> </div> </div>	<div style="display: flex; flex-direction: row-reverse;"> <div style="margin-right: 10px;">                               </div> <div> <p>17. Where the mains plug or an appliance coupler is used as the disconnect device, the disconnect device shall remain readily operable. To disconnect the equipment from the mains remove the mains plug from the mains outlet.</p> <p>18. Do not overload wall sockets, extension leads or multiple socket outlets. This could cause fire or electric shock. Make sure that the maximum permissible power of each component of the installation is not exceeded.</p> <p>19. WARNING: To reduce the risk of fire or electric shock, do not expose this device to water, rain or moisture. In addition, the device must not be exposed to dripping or splashing liquid and no objects filled with liquids, such as vases, should be placed on the device.</p> <p>20. Do not insert any objects into the device's ventilation openings. They could come into contact with one of the high-voltage components or short-circuit them and cause a fire or electric shock.</p> <p>21. When using the device, the ambient temperature should not exceed 95°F (35 degrees Celsius).</p> <p>22. Do not use this device in tropical climates.</p> <p>23. Do not use this device at altitudes of more than 2,000 m (6,500 ft).</p> <p>24. If the device has been transported from a cold environment to a warm environment, make sure no condensation has accumulated before connecting the power cable.</p> <p>25. Always leave a distance of at least 5cm (2") around the product for proper ventilation.</p> <p>26. Do not place naked flame sources, such as lit candles, near the device.</p> <p>27. The appliance should only be mounted on a wall or ceiling if the manufacturer allows for this.</p> <p>28. This product has sharp corners. Handle it with care.</p> <p>29. Do not attempt to repair this device yourself. Opening the device may be dangerous. Contact a qualified professional for all work on the device.</p> <p>30. When replacement components are needed, use only the components specified by the manufacturer or components with identical technical features to those of the original product. Using non-compliant components could cause fires, electric shocks or other risks.</p> </div> </div>	<div style="display: flex; flex-direction: row-reverse;"> <div style="margin-right: 10px;">                               </div> <div> <p>31. After any maintenance or repair work on the device, test it to check that it is working safely.</p> <p>32. Turn the source to minimum before connecting the products and turning up the volume. Once the products are in place, gradually increase the volume to a reasonable and comfortable level.</p> <p>33. To avoid damaging your hearing, do not listen to loudspeakers at high volumes for long periods of time. Listening to loudspeakers at an excessive volume can cause damage to the user's ears and may lead to hearing problems (temporary or permanent deafness, buzzing in the ears, tinnitus, hyperacusis). Exposing your ears to a volume higher than 85dB SPL-LAeq for several hours can irreversibly damage your hearing.</p> <p>34. After removing the product from its packaging, keep the packaging out of the reach of children. It could present a suffocation risk.</p> <p>35. Some users who are not self-sufficient enough to use the product on their own without danger. In particular, children under 14 or people with some types of disabilities must be supervised and/or accompanied when using the device.</p> <p>USA : Federal Communication Commission Interference Statement This device complies with Part 15 of the FCC Rules. Operation is subject to the following two conditions: (1) This device may not cause harmful interference, and (2) this device must accept any interference received, including interference that may cause undesired operation. This equipment has been tested and found to comply with the limits for a Class B digital device, pursuant to Part 15 of the FCC Rules. These limits are designed to provide reasonable protection against harmful interference in a residential installation. However, there is no guarantee that interference will not occur in a particular installation.</p> <p>Canada : Industry Canada Statement This device complies with ISED's licence-exempt RSSs. Operation is subject to the following two conditions: (1) This device may not cause harmful interference, and (2) this device must accept any interference received, including interference that may cause undesired operation.</p> </div> </div>













































	<div style="border: 1px solid black; padding: 5px; text-align: center;"> <p>CAUTION</p> <p>RISK OF ELECTRIC SHOCK DO NOT OPEN</p> </div>	
<p>Der Blitz in einem gleichseitigen Dreieck warnt den Benutzer, dass Hochspannung am Gerät anliegt, die das Risiko eines Stromschlags mit sich bringt.</p>	<p>WARNUNG: Um die Gefahr eines Stromschlags zu vermeiden, entfernen Sie nicht die Abdeckung (oder die Rückseite) des Geräts. Es gibt in diesem Gerät keine vom Benutzer zu wartenden Teile. Wenden Sie sich bei Wartungs- oder Reparaturarbeiten an qualifiziertes Fachpersonal.</p>	<p>Warnsymbol. Dieses Symbol soll den Benutzer auf wichtige Anweisungen in der Bedienungsanleitung hinweisen, die sich auf die Handhabung, den Betrieb und die Wartung des Geräts beziehen.</p>
<div style="display: flex; flex-direction: column;"> <div style="margin-bottom: 10px;"></div> <div style="margin-bottom: 10px;"></div> <div style="margin-bottom: 10px;"></div> <div style="margin-bottom: 10px;"></div> <div style="margin-bottom: 10px;"></div> <div style="margin-bottom: 10px;"></div> <div style="margin-bottom: 10px;"></div> <div style="margin-bottom: 10px;"></div> <div style="margin-bottom: 10px;"></div> <div style="margin-bottom: 10px;"></div> <div style="margin-bottom: 10px;"></div> <div style="margin-bottom: 10px;"></div> <div style="margin-bottom: 10px;"></div> <div style="margin-bottom: 10px;"></div> <div style="margin-bottom: 10px;"></div> <div style="margin-bottom: 10px;"></div> <div style="margin-bottom: 10px;"></div> <div style="margin-bottom: 10px;"></div> <div style="margin-bottom: 10px;"></div> <div style="margin-bottom: 10px;"></div> <div style="margin-bottom: 10px;"></div> <div style="margin-bottom: 10px;"></div> <div style="margin-bottom: 10px;"></div> <div style="margin-bottom: 10px;"></div> <div style="margin-bottom: 10px;"></div> <div style="margin-bottom: 10px;"></div> <div style="margin-bottom: 10px;"></div> <div style="margin-bottom: 10px;"></div> <div style="margin-bottom: 10px;"></div> </div>	<div style="display: flex; flex-direction: column;"> <div style="margin-bottom: 10px;"></div> <div style="margin-bottom: 10px;"></div> <div style="margin-bottom: 10px;"></div> <div style="margin-bottom: 10px;"></div> <div style="margin-bottom: 10px;"></div> <div style="margin-bottom: 10px;"></div> <div style="margin-bottom: 10px;"></div> <div style="margin-bottom: 10px;"></div> <div style="margin-bottom: 10px;"></div> <div style="margin-bottom: 10px;"></div> <div style="margin-bottom: 10px;"></div> <div style="margin-bottom: 10px;"></div> <div style="margin-bottom: 10px;"></div> <div style="margin-bottom: 10px;"></div> <div style="margin-bottom: 10px;"></div> <div style="margin-bottom: 10px;"></div> <div style="margin-bottom: 10px;"></div> <div style="margin-bottom: 10px;"></div> <div style="margin-bottom: 10px;"></div> <div style="margin-bottom: 10px;"></div> <div style="margin-bottom: 10px;"></div> <div style="margin-bottom: 10px;"></div> <div style="margin-bottom: 10px;"></div> <div style="margin-bottom: 10px;"></div> <div style="margin-bottom: 10px;"></div> <div style="margin-bottom: 10px;"></div> <div style="margin-bottom: 10px;"></div> <div style="margin-bottom: 10px;"></div> <div style="margin-bottom: 10px;"></div> </div>	<div style="display: flex; flex-direction: column;"> <div style="margin-bottom: 10px;"></div> <div style="margin-bottom: 10px;"></div> <div style="margin-bottom: 10px;"></div> <div style="margin-bottom: 10px;"></div> <div style="margin-bottom: 10px;"></div> <div style="margin-bottom: 10px;"></div> <div style="margin-bottom: 10px;"></div> <div style="margin-bottom: 10px;"></div> <div style="margin-bottom: 10px;"></div> <div style="margin-bottom: 10px;"></div> <div style="margin-bottom: 10px;"></div> <div style="margin-bottom: 10px;"></div> <div style="margin-bottom: 10px;"></div> <div style="margin-bottom: 10px;"></div> <div style="margin-bottom: 10px;"></div> <div style="margin-bottom: 10px;"></div> <div style="margin-bottom: 10px;"></div> <div style="margin-bottom: 10px;"></div> <div style="margin-bottom: 10px;"></div> <div style="margin-bottom: 10px;"></div> <div style="margin-bottom: 10px;"></div> <div style="margin-bottom: 10px;"></div> <div style="margin-bottom: 10px;"></div> <div style="margin-bottom: 10px;"></div> <div style="margin-bottom: 10px;"></div> <div style="margin-bottom: 10px;"></div> <div style="margin-bottom: 10px;"></div> <div style="margin-bottom: 10px;"></div> <div style="margin-bottom: 10px;"></div> </div>



1. Lesen Sie diese Anweisungen.
 2. Bewahren Sie diese Anweisungen auf.
 3. Beachten Sie alle Warnungen.
 4. Befolgen Sie alle Anweisungen.
 5. Verwenden Sie dieses Gerät nicht in der Nähe von Wasser.
 6. Trocknen Sie das Gerät nur mit einem trockenen Tuch.
 7. Blockieren Sie keine Lüftungsöffnungen. Installieren Sie das Gerät gemäß den Anweisungen des Herstellers.
 8. Installieren Sie das Gerät nicht in der Nähe von Wärmequellen, z. B. Heizkörpern, Wärmespeichern, Öfen oder Geräten (z. B. Heizstärkern), die Wärme abgeben.
 9. Nehmen Sie keine Veränderungen vor, die die Sicherheitsfunktion des polarisierten Steckers beeinträchtigen. Ein polarisierter Netzstecker hat zwei Stifte, bei denen einer breiter ist als der andere. Der breite Stift dient Ihrer Sicherheit. Wenn der mitgelieferte Stecker nicht in Ihre Steckdose passt, wenden Sie sich an einen Elektriker, um die veraltete Steckdose auszutauschen.
 10. Schützen Sie das Netzkabel vor Betreten oder Einklemmen, insbesondere an Steckern, Steckdosen und der Stelle, an der es aus dem Gerät austritt.
 11. Verwenden Sie nur vom Hersteller empfohlenes Zubehör.
 12. Verwenden Sie das Gerät nur mit dem Wagen, Ständer, Stativ, Wandhalter oder Tisch, der mitgeliefert oder vom Hersteller empfohlen wird. Wenn ein Wagen verwendet wird, ist beim Bewegen der Kombination von Wagen und Geräte Vorsicht geboten, um Verletzungen durch Umkippen zu vermeiden.
 13. Ziehen Sie den das Netzkabel dieses Geräts bei Gewittern oder bei längerer Nichtbenutzung aus der Steckdose.
 14. Wartungsarbeiten dürfen nur von qualifizierten Technikern ausgeführt werden. Eine Wartung ist erforderlich, falls das Gerät in irgendeiner Weise beschädigt wurde, z. B. wenn das Netzkabel oder der Stecker beschädigt ist, Flüssigkeit darüber verschüttet wurde oder Gegenstände in das Gerät gefallen sind, das Gerät Regen oder Feuchtigkeit ausgesetzt war, nicht normal funktioniert oder fallen gelassen wurde.
 15. Schließen Sie dieses Produkt nur an die auf dem Gerät angegebene Art der Netzversorgung an. Wenn Sie sich nicht sicher sind, welche Art von Netzanschluss für das Produkt

oder Ihre Elektroinstallation erforderlich ist, fragen Sie Ihren Installateur oder Ihren Stromversorger. Geräte, die für die Verwendung mit einer Batterie oder einer anderen Stromquelle vorgesehen sind, finden Sie in der Bedienungsanleitung.
 16. Dieses Produkt ist ein Gerät der Klasse 1. Schließen Sie das Gerät nur mit dem mitgelieferten Netzstecker an, der einen Erdanschluss beinhaltet.
 17. Wird der Netzstecker oder der Geräterestecker als Abschalteneinrichtung verwendet, muss die Abschalteneinrichtung jederzeit uneingeschränkt bedient werden können. Um das Gerät vom Netz zu trennen, ziehen Sie den Netzstecker aus der Steckdose.
 18. Überlasten Sie keine Wandsteckdosen, Verlängerungskabel oder Mehrfachsteckdosen. Dies könnte einen Brand oder elektrischen Schlag verursachen. Achten Sie darauf, dass die maximal zulässige Leistung der einzelnen Komponenten der Anlage nicht überschritten wird.
 19. WARNUNG: Um die Gefahr von Bränden oder Stromschlägen zu verringern, vermeiden Sie, dass dieses Gerät Wasser, Regen oder Feuchtigkeit ausgesetzt wird. Darüber hinaus darf das Gerät keinen Tropfen oder Spritzern ausgesetzt werden und es dürfen keine mit Flüssigkeiten gefüllten Gegenstände, wie z. B. Vasen, auf das Gerät gestellt werden.
 20. Stecken Sie keine Gegenstände in die Lüftungsöffnungen des Gerätes. Sie können mit einer der Hochspannungskomponenten in Berührung kommen oder diese kurzschließen und einen Brand oder Stromschlag verursachen.
 21. Bei der Verwendung des Geräts sollte die Umgebungstemperatur 35 Grad Celsius (95°F) nicht überschreiten.
 22. Verwenden Sie dieses Gerät nicht in tropischen Klimazonen.
 23. Verwenden Sie dieses Gerät nicht in Höhen von mehr als 2.000 m (6.500 ft).
 24. Wenn das Gerät von einer kalten in eine warme Umgebung bewegt wurde, stellen Sie sicher, dass sich vor dem Anschluss des Netzkabels kein Kondenswasser angesammelt hat.
 25. Halten Sie für eine gute Belüftung immer einen Abstand von mindestens 5 cm (2") um das Gerät herum ein.
 26. Stellen Sie keine offenen Feuerquellen, wie z. B. brennende Kerzen, in der Nähe des Geräts auf.

27. Das Gerät sollte nur an der Wand oder an der Decke montiert werden, wenn der Hersteller dies zulässt.
 28. Dieses Produkt hat scharfe Ecken. Behandeln Sie es mit Vorsicht.
 29. Versuchen Sie nicht, dieses Gerät selbst zu reparieren. Das Öffnen des Geräts kann gefährlich sein. Wenden Sie sich für alle Arbeiten an dem Gerät an qualifizierte Fachleute.
 30. Wenn Ersatzkomponenten benötigt werden, verwenden Sie nur die vom Hersteller angegebenen Komponenten oder Komponenten mit den gleichen technischen Merkmalen wie das Originalprodukt. Die Verwendung nicht konformer Komponenten kann zu Bränden, Stromschlägen oder anderen Gefahren führen.
 31. Testen Sie nach Wartungs- oder Reparaturarbeiten das Gerät, um sicherzustellen, dass es sicher funktioniert.
 32. Stellen Sie die Quelle auf Minimum, bevor Sie die Produkte anschließen und die Lautstärke erhöhen. Sobald die Geräte angeschlossen sind, erhöhen Sie die Lautstärke allmählich auf einen angemessenen und angenehmen Pegel.
 33. Um Ihr Gehör nicht zu schädigen, sollten Sie Lautsprecher nicht über einen längeren Zeitraum mit hoher Lautstärke hinweg hören. Hören von Lautsprechern mit zu hoher Lautstärke kann zu Schäden an den Ohren des Benutzers und zu Hörproblemen führen (vorübergehende oder dauerhafte Taubheit, Summen in den Ohren, Tinnitus, Geräuschüberempfindlichkeit). Wenn Sie Ihre Ohren über mehrere Stunden hinweg einer Lautstärke von mehr als 85 dB SPL-LAeq aussetzen, kann Ihr Gehör irreversibel geschädigt werden.
 34. Wenn Sie das Produkt aus der Verpackung genommen haben, bewahren Sie die Verpackung außerhalb der Reichweite von Kindern auf. Es könnte ein Erstickenrisiko darstellen.
 35. Einige Benutzer sind nicht selbstständig genug, um das Produkt sicher allein zu verwenden, insbesondere Kinder unter 14 Jahren oder Menschen mit bestimmten Behinderungen müssen bei der Verwendung des Geräts beaufsichtigt und/oder betreut werden.











































































	<div style="border: 1px solid black; padding: 5px; text-align: center;"> <p>CAUTION</p> <p>RISK OF ELECTRIC SHOCK DO NOT OPEN</p> </div>	
<p>Il fulmine all'interno di un triangolo equilatero avverte l'utente della presenza di alta tensione all'interno del dispositivo che può costituire un rischio di scossa elettrica.</p>	<p>ATTENZIONE: per evitare il rischio di scosse elettriche, non rimuovere la copertura (o la parte posteriore) del dispositivo. Nel dispositivo non sono presenti parti aggiustabili dall'utente. Per la manutenzione o eventuali riparazioni, rivolgersi a un professionista qualificato.</p>	<p>Simbolo di avvertenza. Questo simbolo avverte l'utente della presenza di importanti istruzioni contenute nel manuale d'uso e relative al maneggio, al funzionamento e alla manutenzione del dispositivo.</p>
<div style="display: flex; flex-direction: column;"> <div style="margin-bottom: 10px;"></div> <div style="margin-bottom: 10px;"></div> <div style="margin-bottom: 10px;"></div> <div style="margin-bottom: 10px;"></div> <div style="margin-bottom: 10px;"></div> <div style="margin-bottom: 10px;"></div> <div style="margin-bottom: 10px;"></div> <div style="margin-bottom: 10px;"></div> <div style="margin-bottom: 10px;"></div> <div style="margin-bottom: 10px;"></div> <div style="margin-bottom: 10px;"></div> <div style="margin-bottom: 10px;"></div> <div style="margin-bottom: 10px;"></div> <div style="margin-bottom: 10px;"></div> <div style="margin-bottom: 10px;"></div> <div style="margin-bottom: 10px;"></div> <div style="margin-bottom: 10px;"></div> <div style="margin-bottom: 10px;"></div> <div style="margin-bottom: 10px;"></div> <div style="margin-bottom: 10px;"></div> <div style="margin-bottom: 10px;"></div> <div style="margin-bottom: 10px;"></div> <div style="margin-bottom: 10px;"></div> <div style="margin-bottom: 10px;"></div> <div style="margin-bottom: 10px;"></div> <div style="margin-bottom: 10px;"></div> <div style="margin-bottom: 10px;"></div> <div style="margin-bottom: 10px;"></div> <div style="margin-bottom: 10px;"></div> <div style="margin-bottom: 10px;"></div> <div style="margin-bottom: 10px;"></div> </div> <p>1. Leggere queste istruzioni. 2. Conservare queste istruzioni. 3. Tenere presenti tutte le avvertenze. 4. Attenersi a tutte le istruzioni. 5. Non utilizzare questo impianto in prossimità dell'acqua. 6. Pulire esclusivamente con un panno asciutto. 7. Non bloccare le aperture per la ventilazione. Eseguire l'installazione attendendosi alle istruzioni del produttore. 8. Non installare in prossimità di fonti di calore quali radiatori, diffusori di aria calda, stufe o altri dispositivi, ivi inclusi gli amplificatori, che emanano calore. 9. Non danneggiare la funzione di sicurezza della spina polarizzata (comune). Una spina polarizzata è dotata di due lamelle, una più larga dell'altra. La più larga serve a garantire la sicurezza dell'utente. Nel caso in cui la spina in dotazione non sia compatibile con la presa, rivolgersi a un elettricista per la sostituzione della presa obsoleta. 10. Proteggere il cavo di alimentazione, affinché non venga calpestato o schiacciato, in particolare in prossimità di spine, prese e nel punto in cui fuoriesce dal dispositivo. 11. Utilizzare solo gli accessori/strumenti di corredo indicati dal produttore. 12. Utilizzare esclusivamente con il carrello, il supporto, il cavalletto, il sostegno o il piano di appoggio indicati dal produttore o in vendita con l'impianto. Nel caso in cui venga utilizzato un carrello, è necessario prestare attenzione durante lo spostamento dell'impianto per evitare lesioni da caduta. 13. In caso di temporali con fulmini o di mancato utilizzo per un periodo di tempo prolungato, scollegare l'impianto dall'alimentazione. 14. Per assistenza, contattare personale qualificato. L'assistenza è necessaria nel caso in cui l'impianto abbia subito danni, ad esempio, in caso di danneggiamento del cavo di alimentazione o della spina, contatto con liquidi o urto con altri oggetti, esposizione a pioggia o umidità, funzionamento anomalo o caduta. 15. Collegare questo prodotto soltanto al tipo di alimentazione elettrica indicato sul dispositivo. In caso di incertezza a proposito del tipo di alimentazione elettrica richiesto dal prodotto o dall'impianto elettrico, chiedere all'installatore o al fornitore di energia elettrica.</p>	<div style="display: flex; flex-direction: column;"> <div style="margin-bottom: 10px;"></div> <div style="margin-bottom: 10px;"></div> <div style="margin-bottom: 10px;"></div> <div style="margin-bottom: 10px;"></div> <div style="margin-bottom: 10px;"></div> <div style="margin-bottom: 10px;"></div> <div style="margin-bottom: 10px;"></div> <div style="margin-bottom: 10px;"></div> <div style="margin-bottom: 10px;"></div> <div style="margin-bottom: 10px;"></div> <div style="margin-bottom: 10px;"></div> </div> <p>Per i dispositivi che richiedono l'uso di una batteria o un altro tipo di alimentazione, consultare il manuale d'uso. 16. Questo è un apparecchio di Classe I. Collegare il dispositivo utilizzando esclusivamente la spina in dotazione, che include una messa a terra. Il dispositivo deve essere collegato a una presa messa a terra. 17. Le eventuali spine o accoppiatori utilizzati come dispositivi di scolliegamento devono essere sempre prontamente accessibili. Per scollegare l'apparecchiatura dalla rete elettrica, disinserire la spina dalla presa. 18. Non sovraccaricare le prese elettriche a muro, le prolunghe o gli adattatori multipli. Ciò può comportare un rischio d'incendio o di scossa elettrica. Assicurarsi che la potenza massima consentita di ciascun componente dell'impianto non venga superata. 19. ATTENZIONE: per ridurre il rischio d'incendio o di scosse elettriche, non esporre il dispositivo ad acqua, pioggia o umidità. Inoltre, il dispositivo non deve essere esposto al contatto con liquidi o spruzzi. Non collocare sul dispositivo contenitori pieni di liquido, come ad esempio vasi. 20. Non inserire nessun oggetto attraverso i fori di ventilazione del dispositivo. Potrebbe venire a contatto con componenti ad alta tensione o cortocircuitarli, causando incendi o scosse elettriche. 21. Durante l'utilizzo del dispositivo, la temperatura dell'ambiente circostante non deve superare i 35 gradi Celsius. 22. Non utilizzare il dispositivo in climi tropicali. 23. Non utilizzare il dispositivo ad altitudini superiori ai 2.000 m (6.500 ft). 24. Se il dispositivo è stato trasportato da un ambiente freddo a un ambiente caldo, verificare che non si sia accumulata condensa prima di collegare il cavo di alimentazione. 25. Lasciare sempre una distanza di almeno 5 cm (2") attorno al prodotto per consentirne un'adeguata ventilazione. 26. Non avvicinare al dispositivo fiamme dirette, come candele accese. 27. L'apparecchio può essere montato su una parete o un soffitto soltanto se il produttore lo consente. 28. Questo prodotto presenta spigoli affilati. Maneggiare con cura.</p>	<div style="display: flex; flex-direction: column;"> <div style="margin-bottom: 10px;"></div> <div style="margin-bottom: 10px;"></div> <div style="margin-bottom: 10px;"></div> <div style="margin-bottom: 10px;"></div> <div style="margin-bottom: 10px;"></div> <div style="margin-bottom: 10px;"></div> <div style="margin-bottom: 10px;"></div> <div style="margin-bottom: 10px;"></div> <div style="margin-bottom: 10px;"></div> </div> <p>29. Non provare mai ad eseguire riparazioni di propria iniziativa. Aprire il dispositivo può essere pericoloso. Contattare un professionista qualificato per eseguire qualsiasi tipo di lavoro sul dispositivo. 30. In caso siano necessarie parti di ricambio, utilizzare esclusivamente le parti specificate dal produttore o parti dalle caratteristiche tecniche identiche a quelle del prodotto originale. L'utilizzo di parti non conformi può causare incendi, scosse elettriche o comportare altri rischi. 31. In seguito ad operazioni di riparazione o manutenzione del dispositivo, collaudarlo per assicurarne il funzionamento in sicurezza. 32. Abbassare il volume della sorgente al minimo prima di collegare i prodotti e aumentare il volume. Una volta preparati i prodotti, aumentare gradualmente il volume fino a raggiungere un livello ragionevole e gradevole. 33. Per evitare di danneggiare l'udito, non ascoltare il suono proveniente dai diffusori a un volume elevato per lunghi periodi di tempo. L'ascolto dei diffusori a un volume eccessivo può danneggiare l'orecchio dell'utente e può portare a problemi di udito (sordità temporanea o permanente, ronzii, acufeni o iperacusia). L'esposizione dell'apparato uditivo a un volume superiore a 85 dB SPL-LAeq per svariate ore può danneggiare l'udito in modo irreversibile. 34. Dopo aver rimosso il prodotto dalla confezione, tenerla lontano dalla portata dei bambini. Potrebbe comportare un rischio di soffocamento. 35. Alcuni utenti non sono sufficientemente autonomi da poter utilizzare questo prodotto da soli in sicurezza. In particolare, i bambini dall'età inferiore ai 14 anni o le persone con alcuni tipi di disabilità devono essere supervisionati e/o accompagnati durante l'utilizzo del dispositivo.</p>

	<div style="border: 1px solid black; padding: 5px; text-align: center;"> CAUTION RISK OF ELECTRIC SHOCK DO NOT OPEN </div>	
<p>El rayo representado en un triángulo equilátero advierte al usuario de que en el aparato hay altas tensiones que pueden suponer un riesgo de choque eléctrico.</p>	<p>ADVERTENCIA: Para prevenir el riesgo de choque eléctrico, no retire la tapa (ni la parte trasera) de este aparato. Ningún componente de este aparato es reemplazable por el usuario. Para operaciones de mantenimiento o de reparación, póngase en contacto con un profesional cualificado.</p>	<p>Símbolo de advertencia. Este símbolo se ha diseñado para advertir al usuario de la presencia de instrucciones importantes mencionadas en el manual de usuario y relacionadas con el manejo, funcionamiento y mantenimiento del dispositivo.</p>
<div style="display: flex; flex-direction: row-reverse;"> <div style="margin-right: 10px;">                       </div> <div style="flex-grow: 1;"> <ol style="list-style-type: none"> 1. Lea estas instrucciones. 2. Conserve estas instrucciones. 3. Tenga en consideración las advertencias. 4. Respete todas las instrucciones. 5. No utilice este aparato cerca del agua. 6. Limpíelo únicamente con un paño seco. 7. No obstruya ningún orificio de ventilación. Instale el aparato según las instrucciones del fabricante. 8. No instale el aparato cerca de fuentes de calor, como radiadores, calefactores, estufas u otros aparatos (incluidos los amplificadores) que produzcan calor. 9. No invalide el objetivo de seguridad de la toma polarizada (común). Las tomas polarizadas presentan dos clavijas, una más ancha que la otra. La clavija ancha es un dispositivo de seguridad. Si el enchufe suministrado no se adapta a su toma de corriente, consulte con un electricista para reemplazar la toma. 10. Proteja el cable para que no se pueda pisar, apalstar ni quedar aprisionado, especialmente en el enchufe, las tomas de corriente y la salida del cable desde el equipo. 11. Utilice solo accesorios/complementos especificados por el fabricante. 12. Utilice únicamente el carro, soporte, tripode, bastidor o mesa especificado por el fabricante o que se venda con el aparato. Cuando utilice un carro, extreme la prudencia al desplazarlo con el aparato para evitar posibles lesiones debidas a su vuelco. 13. Desenchufe el aparato en caso de tormenta o si no lo utiliza durante un período de tiempo prolongado. 14. Encargue todo el mantenimiento a personal cualificado para ello. El mantenimiento será necesario siempre que se produzcan incidentes como el deterioro del cable o el enchufe, el derrame de líquidos o la introducción de objetos en el interior del aparato, la exposición a la lluvia o a la humedad, el mal funcionamiento o la caída del equipo. 15. Conecte solo este producto con el tipo de alimentación eléctrica indicado en el dispositivo. Si no sabe qué tipo de alimentación eléctrica se necesita para el producto o su instalación eléctrica, pregunte a su instalador o a su proveedor de electricidad. </div> </div>	<div style="display: flex; flex-direction: row-reverse;"> <div style="margin-right: 10px;">            </div> <div style="flex-grow: 1;"> <p>Si el aparato está previsto para un uso con batería u otra fuente de alimentación, consulte el manual de usuario.</p> <p>16. Este producto es un aparato de clase I. Para conectar este aparato utilice únicamente el enchufe con toma de tierra suministrado. Este aparato debe estar conectado a una toma de corriente protegida con una conexión a tierra.</p> <p>17. Donde se utilice el enchufe de red o un acoplador de aparato como un dispositivo de desconexión, este deberá ser fácilmente accionable. Para desconectar el equipo de la red, saque el enchufe de red de la toma.</p> <p>18. No sobrecargue las tomas de corriente, los alargadores ni las tomas múltiples, ya que podría provocar un incendio o un choque eléctrico. Asegúrese de que no se supera la potencia máxima admisible de cada componente de la instalación.</p> <p>19. ADVERTENCIA: Para reducir el riesgo de incendio o de choque eléctrico, no exponga este aparato al agua, la lluvia o la humedad. Asimismo, no debe exponerse a goteo o salpicaduras de líquidos ni debe colocarse sobre el aparato ningún objeto lleno de líquido, como floreros.</p> <p>20. No introduzca ningún objeto en los orificios de ventilación del aparato. Dicho objeto podría entrar en contacto con componentes sometidos a altas tensiones y producir un cortocircuito, provocando un incendio o un choque eléctrico.</p> <p>21. Cuando utilice el aparato, la temperatura ambiente no debería superar los 35 grados Celsius.</p> <p>22. No utilice este aparato en climas tropicales.</p> <p>23. No utilice este aparato en altitudes superiores a 2000 m (6500 pies).</p> <p>24. Si traslada el aparato desde un entorno frío a otro caliente, asegúrese de que no se haya producido condensación antes de conectar el cable de alimentación.</p> <p>25. Deje siempre una distancia mínima de 5 cm (2 pulgadas) en torno al equipo para garantizar una ventilación adecuada.</p> <p>26. No coloque ninguna fuente de llamas desnudas, como velas encendidas, cerca del aparato.</p> <p>27. El aparato solo debería instalarse en una pared o techo si el fabricante lo permite.</p> <p>28. Este producto tiene esquinas afiladas. Manéjelo con cuidado.</p> </div> </div>	<div style="display: flex; flex-direction: row-reverse;"> <div style="margin-right: 10px;">           </div> <div style="flex-grow: 1;"> <ol style="list-style-type: none"> 29. No intente reparar este aparato por sus propios medios. Abrir el dispositivo puede ser peligroso. Para cualquier intervención en el dispositivo, póngase en contacto con un profesional cualificado. 30. Cuando se necesiten componentes de repuesto, use solo los componentes especificados por el fabricante o componentes que cuenten con funcionalidades técnicas idénticas que las del producto original. El uso de componentes inadecuados puede provocar incendios, choques eléctricos u otros riesgos. 31. Después de cualquier operación de mantenimiento o reparación, realice una prueba para garantizar que el aparato funciona en condiciones de seguridad. 32. Ponga la fuente al mínimo antes de conectar los productos y subir el volumen. Una vez que los productos estén en su sitio, suba el volumen gradualmente hasta alcanzar un nivel sonoro razonable y cómodo. 33. Para evitar posibles daños auditivos, no escuche los altavoces a volumen alto durante largos períodos de tiempo. Escuchar altavoces a un volumen excesivo puede causar daños en el oído y provocar trastornos auditivos (sordera temporal o permanente, zumbidos en los oídos, acúfenos, hiperacusia). Si expone sus oídos a un volumen superior a 85 dB de SPL-LAeq durante varias horas puede dañar de forma irreversible su audición. 34. Tras sacar el producto de su embalaje, guarde el embalaje fuera del alcance de los niños, ya que, de lo contrario, podría haber peligro de asfixia. 35. Algunos usuarios no tienen suficiente autonomía para usar el producto por su cuenta sin peligro. En especial, los menores de 14 años o las personas con algún tipo de discapacidad deben contar con supervisión o estar acompañados cuando utilicen el aparato. </div> </div>





	<div style="text-align: center; background-color: black; color: white; padding: 5px;">CAUTION</div> <div style="text-align: center; background-color: black; color: white; padding: 5px;">RISK OF ELECTRIC SHOCK DO NOT OPEN</div>	
<p>O raio num triângulo equilátero avisa o utilizador que o dispositivo tem alta tensão que pode resultar em risco de choque elétrico.</p>	<p>AVISO : Para evitar qualquer risco de choque elétrico, não retire a cobertura (ou a parte traseira) do dispositivo. Este dispositivo não possui peças que possam receber assistência por parte do utilizador. Para efeitos de manutenção ou reparação, contacte um profissional qualificado.</p>	<p>O ponto de exclamação dentro de um triângulo equilátero, tem por objetivo alertar o usuário para a presença de instruções importantes mencionadas no manual de uso e relativas a implementação e manutenção do aparelho.</p>
<p>1. Leia estas instruções. 2. Conserve estas instruções. 3. Respeite todos os avisos. 4. Siga todas as instruções. 5. Não utilize este dispositivo perto de água. 6. Limpe apenas com um pano seco. 7. Não obstrua nenhum orifício de ventilação. Instale o dispositivo de acordo com as instruções do fabricante. 8. Não instale o dispositivo perto de uma fonte de calor, tal como um radiador, um fogão, uma boca de aquecimento, ou de qualquer outro dispositivo (incluindo amplificadores) que emita calor. 9. Não abdique do dispositivo de segurança da ficha polarizada. Uma ficha polarizada dispõe de dois pinos, sendo um maior do que o outro. O pino maior existe para sua segurança. Se a ficha fornecida não entrar na tomada que tem disponível, consulte um eletricitista para efeitos de substituição da tomada obsoleta. 10. Certifique-se de que o cabo de alimentação não pode ser pisado, esmagado nem dobrado. Deve ser dada especial atenção à ficha de alimentação e à ligação do cabo com o dispositivo. 11. Utilize apenas os acessórios recomendados pelo fabricante. 12. Utilize apenas os carros de deslocamento, pés, tripés, suportes ou mesas recomendados pelo fabricante ou vendidos com o dispositivo. Quando for utilizado um carro de deslocamento, redobre a atenção durante a deslocação do conjunto carro/dispositivo de forma a evitar qualquer lesão decorrente a quedas. 13. Desligue o dispositivo em caso de trovoadas ou durante períodos prolongados durante os quais o dispositivo não seja utilizado. 14. Todos os serviços de manutenção devem ser realizados por técnicos qualificados. É necessário efetuar um serviço de manutenção no seguimento de qualquer dano causado no dispositivo, como deterioração do cabo ou da ficha de alimentação, derramamento de líquidos ou inserção de objetos no interior do dispositivo, exposição à chuva ou humidade, avaria ou queda do dispositivo. 15. Este produto apenas deve ser ligado ao tipo de tomada de alimentação indicado no</p>	<p>dispositivo. Em caso de dúvida sobre o tipo de alimentação da instalação elétrica necessária para o produto, consulte o vendedor do produto ou o fornecedor de electricidade. Relativamente aos dispositivos destinados a utilização através de bateria ou de outra fonte de alimentação, consulte o manual de utilização. 16. Este produto pertence aos dispositivos de classe I. Ligue o dispositivo apenas através da ficha elétrica fornecida que tem ligação à terra. O dispositivo deve ser ligado a uma tomada elétrica com ligação à terra. 17. Nos casos em que a tomada da rede de alimentação ou uma tomada no dispositivo ou o computador On/Off seja utilizado como meio de desativação, este meio deve permanecer sempre acessível. 18. Não sobrecarregue as tomadas de parede, as extensões elétricas nem as tomadas múltiplas. Tal poderá levar a incêndios ou choques elétricos. Não exceda a potência máxima permitida para cada elemento da instalação. 19. CUIDADO: Para reduzir o risco de incêndio ou choque elétrico, não exponha este dispositivo à chuva nem à humidade. Além disso, o dispositivo não deve ser exposto a gotejamentos de água ou salpicos e não deve ser colocado sobre o dispositivo qualquer objeto cheio de líquido, como um copo. 20. Nunca insira objetos nos buracos de ventilação do dispositivo. Se o fizer, estes poderão entrar em contacto com os componentes sujeitos a alta tensão ou provocar um curto-circuito, o que por sua vez poderá provocar um incêndio ou choque elétrico. Nunca derrame líquidos no dispositivo. 21. A temperatura ambiente aquando da utilização do dispositivo não deve ser superior a 35 graus Celsius (95 °F). 22. Não utilize este dispositivo em climas tropicais. 23. Não utilize este dispositivo em zonas situadas acima de 2000 m de altitude. 24. Se o dispositivo tiver sido transportado de um ambiente frio para um ambiente quente, certifique-se de que não ocorre qualquer fenómeno de condensação antes de ligar o cabo de alimentação.</p>	<p>25. Deixe sempre uma distância de, pelo menos, 5 cm (2") em redor do produto, para que haja uma ventilação adequada. 26. Não coloque fontes de chamas desprotegidas, como velas acesas, sobre o dispositivo. 27. O dispositivo não deve ser montado numa parede ou num teto, exceto se assim previsto pelo fabricante. 28. Este produto tem cantos afiados. Manuseie-o com cuidado. 29. Não tente reparar este dispositivo. Abri-lo pode resultar em exposição a tensões perigosas ou outros riscos. Contacte um profissional qualificado para a realização de qualquer trabalho de manutenção. 30. Quando for necessária a substituição de componentes, utilize somente componentes especificados pelo fabricante ou com características idênticas ao original. Componentes não conformes podem causar incêndios, choques elétricos ou outros riscos. 31. Após uma intervenção ou reparação no dispositivo, efetue testes para verificar se o produto funciona em segurança. 32. Coloque o volume no mínimo antes de conectar os produtos a de aumentar o volume. Uma vez colocados os produtos, aumente gradualmente o volume até um nível razoável e agradável. 33. Para evitar prejudicar a sua audição, não ouça colunas em volumes elevados durante períodos prolongados. Ouvir colunas em volumes elevados pode prejudicar a audição do utilizador e resultar em problemas de audição (surdez temporária ou permanente, zumbido nos ouvidos, zúvido, hiperacusia). 34. Uma exposição a volumes excessivos (acima dos 85 dB) durante mais de uma hora pode provocar danos irreparáveis à audição." 34. Antes de desembralar o produto, certifique-se de que coloca a embalagem fora do alcance de crianças. Esta apresenta um risco de asfixia. 35. Alguns utilizadores não têm autonomia suficiente para utilizarem o produto sozinhos sem riscos. Em particular, as crianças com menos de 14 anos e as pessoas portadoras de determinadas deficiências têm obrigatoriamente de ser vigiadas e/ou acompanhadas durante a utilização do dispositivo.</p>

	<div style="text-align: center; background-color: black; color: white; padding: 5px;">CAUTION</div> <div style="text-align: center; background-color: black; color: white; padding: 5px;">RISK OF ELECTRIC SHOCK DO NOT OPEN</div>	
<p>De bliksemschicht in de gelijkzijdige driehoek waarschuwt de gebruiker voor de aanwezigheid van spanning in het apparaat die een elektrische schok kan veroorzaken.</p>	<p>WAARSCHUWING: Verwijder de kap (of achterkant) van het apparaat niet om het risico op elektrische schokken te voorkomen. Geen enkel onderdeel van het apparaat kan door de gebruiker zelf worden vervangen. Laat onderhoud of reparaties uitvoeren door een gekwalificeerde professional.</p>	<p>Waarschuwingssymbool. Dit symbool waarschuwt gebruikers op belangrijke instructies in de gebruikershandleiding met betrekking tot hantering, bediening en onderhoud van het apparaat.</p>
<p>  1. Lees deze instructies.  2. Bewaar deze instructies.  3. Neem de waarschuwingen in acht.  4. Volg alle instructies op.  5. Gebruik dit apparaat niet in de nabijheid van water.  6. Reinig dit apparaat uitsluitend met een droge doek.  7. Blokkeer de ventilatieopeningen niet. Installeer het apparaat overeenkomstig de instructies van de fabrikant.  8. Installeer het apparaat niet in de buurt van hittebronnen, zoals radiatoren, verwarmingsroosters, fornuizen of andere apparaten (waaronder versterkers) waar warmte vanaf komt.  9. Probeer in geen geval de veiligheidsvoorzieningen van de gepolariseerde stekker te omzeilen (algemeen). Een gepolariseerde stekker heeft twee pinnen met verschillende breedten. De bredere pin is voor uw veiligheid. Indien de meegeleverde stekker niet in uw stopcontact past, laat de stekker dan vervangen door een elektricien.  10. Voorkom dat er op het netsnoer kan worden gelopen of dat het kan worden afgekeld, vooral bij stekkers, stopcontacten en waar het snoer het apparaat verlaat.  11. Gebruik uitsluitend door de fabrikant aanbevolen toebehoren/accessoires.  12. Gebruik alleen door de fabrikant aanbevolen of met het apparaat meegeleverde wagens, standaarden, statieven, beugels of tafels. Wanneer u een wagen gebruikt, wees dan voorzichtig bij het verplaatsen van de wagen-apparaatcombinatie, om te voorkomen dat u verwond raakt doordat het geheel omvalt.  13. Haal de stekker van het apparaat uit het stopcontact bij onweer of als u het apparaat gedurende langere tijd niet gebruikt.  14. Alle servicebeurten moeten door gediplomeerd onderhoudspersoneel worden uitgevoerd. Onderhoud is noodzakelijk als het apparaat schade heeft opgelopen, in welke vorm dat ook, wanneer de kabel of het netsnoer zijn beschadigd, als het apparaat is blootgesteld aan vloeistoffen, regen of vocht, als het apparaat slecht functioneert of is gevallen. </p>	<p>  15. Sluit dit product alleen aan op het voor dit apparaat aanbevolen type netvoeding. Als u niet zeker weet op wat voor netvoeding dit product of elektrische installatie moet worden aangesloten, vraag uw installateur of elektriciteitsbedrijf dan om advies. Raadpleeg de gebruikershandleiding voor meer informatie over producten met een batterij of andere voedingsbron.  16. Dit product is een apparaat van klasse I. Sluit het apparaat alleen aan met de meegeleverde netstekker, die is voorzien van een aarde-aansluiting. Het apparaat moet aangesloten worden op een geaard stopcontact.  17. Wanneer de stekker of een koppelkabel wordt gebruikt om de elektrische voeding van het apparaat af te sluiten, dient deze makkelijk bereikbaar te zijn. Haal de stekker uit het stopcontact om het apparaat van de netvoeding af te sluiten.  18. Zorg dat stopcontacten, verlengsnoeren en stekkerdozen niet worden overbelast. Dit zou brand of een elektrische schok kunnen veroorzaken. Zorg dat het maximaal toegestane vermogen van elke component van de installatie niet wordt overschreden.  19. WAARSCHUWING: Stel dit apparaat niet bloot aan water, regen of vocht; dit om het risico op brand of een elektrische schok te verlagen. Zorg ook dat er geen vloeistoffen op het apparaat kunnen druppelen of tegen het apparaat kunnen spatten en plaats geen voorwerpen met vloeistoffen, zoals vazen, op het apparaat.  20. Steek geen objecten in de ventilatieopeningen van het apparaat. Deze kunnen onderdelen die onder hoge spanning staan raken en hierdoor kortsluiting, brand of een elektrische schok veroorzaken.  21. Gebruik het apparaat niet in een omgevingstemperatuur van meer dan 35 graden Celsius.  22. Gebruik dit apparaat niet in een tropisch klimaat.  23. Gebruik dit apparaat niet op een hoogte van meer dan 2000 meter. </p>	<p>  25. Houd minimaal 5 cm ruimte vrij rondom het apparaat voor een goede ventilatie.  26. Plaats nooit een voorwerp met een open vlam, zoals een brandende kaars, in de buurt van het apparaat.  27. Het apparaat mag alleen aan een muur of plafond worden bevestigd als de producent dergelijke montage heeft goedgekeurd.  28. Dit product heeft scherpe hoeken. Ga er voorzichtig mee om.  29. Probeer dit apparaat niet zelf te repareren. Openen van het apparaat kan gevaarlijk zijn. Neem voor alle soorten onderhoud contact op met een gekwalificeerde professional.  30. Wanneer vervangende componenten nodig zijn, gebruik dan alleen de door de fabrikant aanbevolen componenten of componenten met dezelfde technische specificaties als die van het originele product. Het gebruik van onjuiste onderdelen kan brand, elektrische schokken of andere risico's veroorzaken.  31. Stel het apparaat na onderhoud of reparatie om te controleren of het veilig functioneert.  32. Zet het volume van de bron op het laagste niveau alvorens de producten aan te sluiten en stel het volume pas daarna op de gewenste niveau in. Wanneer de producten op hun plaats staan, kunt u het volume geleidelijk aan verhogen tot een redelijk en comfortabel niveau.  33. Zet uw speakers niet gedurende langere tijd op een hoog volume om eventuele gehoorschade te voorkomen. Wanneer u gedurende langere tijd naar luidsprekers op te hoog volume luistert, kan dit uw oren beschadigen en gehoorproblemen veroorzaken (tijdelijke of permanente doofheid, oorsuizen, tinnitus, hyperacusis). Als u uw oren enkele uren lang blootstelt aan een volume van meer dan 85 dB SPL-LAeq kan dat uw gehoor permanent beschadigen.  34. Houd de verpakking nadat het apparaat is uitgepakt uit de buurt van kinderen. De verpakking kan een risico op verstikking zijn.  35. Sommige gebruikers zijn niet zelfstandig genoeg om dit product zonder gevaar alleen te gebruiken. Vooral kinderen onder de 14 en mensen met bepaalde gebreken moeten onder toezicht staan en/of begeleid worden wanneer ze het apparaat gebruiken. </p>































	<div style="text-align: center; border: 1px solid black; padding: 5px;"> CAUTION RISK OF ELECTRIC SHOCK DO NOT OPEN </div>	
<p>Błyskawica w trójkącie równobocznym ostrzega użytkownika, że w urządzeniu występuje wysokie napięcie, które może stwarzać ryzyko porażenia prądem.</p>	<p>OSTRZEŻENIE: Aby zapobiec ryzyku porażenia prądem, nie należy zdejmować pokrywy (ani tyłu) urządzenia. W tym urządzeniu nie ma części, które mogą być serwisowane przez użytkownika. W celu przeprowadzenia czynności serwisowych lub naprawy należy skontaktować się z wykwalifikowanym specjalistą.</p>	<p>Symbol ostrzegawczy. Niniejszy symbol ma ostrzegać użytkownika o obecności ważnych wskazówek wymienionych w instrukcji obsługi i odnoszących się do obsługi, eksploatacji i konserwacji urządzenia.</p>
<p>1. Przeczytaj te instrukcje. 2. Zachowaj te instrukcje. 3. Zwróć uwagę na wszystkie ostrzeżenia. 4. Przestrzegaj wszystkich instrukcji. 5. Nie używaj tego urządzenia w pobliżu wody. 6. Czyść tylko suchą szmatką. 7. Nie należy blokować żadnych otworów wentylacyjnych. Zainstaluj zgodnie z instrukcją producenta. 8. Nie instaluj urządzenia w pobliżu jakichkolwiek źródeł ciepła, takich jak grzejniki, kaloryfery, piece lub inne urządzenia (w tym wzmocniacze) wytwarzające ciepło. 9. Nie pomijaj zabezpieczenia, jakim jest wtyczka polaryzacyjna (wspólna). Wtyczka polaryzacyjna ma dwa bolce, z których jeden jest szerszy od drugiego. Szeroki bolec zaprojektowano dla Twojego bezpieczeństwa. Jeśli dostarczona wtyczka nie pasuje do Twojego gniazdka, skonsultuj się z elektrykiem w celu wymiany niedostosowanego gniazdka. 10. Chroń przewód zasilający przed nadebniciem lub przyniciem, szczególnie przy wtyczkach, gniazdkach i w miejscu, w którym wychodzi on z urządzenia. 11. Używaj tylko osprzętu/ akcesoriów przewidzianych przez producenta. 12. Używaj wyłącznie z wózkiem, stojakiem, statywem, uchwytem lub stołem określonym przez producenta lub sprzedawany razem z urządzeniem. W przypadku korzystania z wózka należy zachować ostrożność podczas przemieszczania zestawu wózek/urządzenie, aby uniknąć obrażeń spowodowanych przewróceniem. 13. Odłączaj to urządzenie od zasilania podczas burz z piorunami lub gdy nie jest używane przez dłuższy czas. 14. Zlecaj wszelkie zadania serwisowe wykwalifikowanym specjalistom. Serwisowanie jest wymagane, jeśli urządzenie zostało w jakikolwiek sposób uszkodzone, np. przewód zasilający lub wtyczka są uszkodzone, rozlano płyn lub przedmioty wpadły do urządzenia, urządzenie było narażone na działanie deszczu lub wilgoci, nie działa normalnie lub zostało upuszczone.</p>	<p>15. Podłączaj ten produkt wyłącznie do takiego rodzaju sieci elektrycznej, jaki jest wskazany na urządzeniu. Jeśli nie masz pewności, jaki rodzaj sieci elektrycznej jest wymagany dla produktu lub Twojej instalacji elektrycznej, zapytaj instalatora lub dostawcę energii elektrycznej. W przypadku urządzeń przeznaczonych do użytku z baterią lub innym źródłem zasilania, patrz instrukcja obsługi. 16. Ten produkt jest urządzeniem klasy I. Urządzenie należy podłączyć wyłącznie za pomocą dostarczonej wtyczki sieciowej, która jest wyposażona w uziemienie. Urządzenie musi być podłączone do uziemionego gniazdka sieciowego. 17. Jeśli do odłączania urządzenia od prądu służy wtyczka elektryczna lub przejściówka, to musi być ona łatwo dostępna. W celu odłączenia urządzenia od prądu, należy wyjąć wtyczkę z gniazdka elektrycznego. 18. Nie przeciążaj gniazdek ściennych, przedłużaczy ani wielu gniazdek. Może to spowodować pożar lub porażenie prądem. Upewnij się, że nie została przekroczona maksymalna dopuszczalna moc każdego elementu instalacji. 19. OSTRZEŻENIE: Aby zmniejszyć ryzyko pożaru lub porażenia prądem, nie należy wystawiać tego urządzenia na działanie wody, deszczu lub wilgoci. Ponadto nie należy narażać sprzętu na zalanie lub ochlapanie ani stawiać na nim naczyń wypełnionych płynem (np. wazonu). 20. Nie wolno wkładać żadnych przedmiotów przez otwory wentylacyjne urządzenia. Mogłyby one zetknąć się z elementami pod wysokim napięciem lub spowodować zwarcie, a w efekcie pożar lub porażenie prądem. 21. Podczas korzystania z urządzenia temperatura otoczenia nie powinna przekraczać 35°C. 22. Nie używaj tego urządzenia w klimacie tropikalnym. 23. Nie używaj urządzenia na terenach powyżej 2000 m n.p.m. 24. Jeśli urządzenie zostało przetransportowane z zimnego otoczenia do ciepłego, przed podłączeniem kabla zasilającego należy upewnić się, że nie nagromadziła się wilgoć. 25. Wokół produktu należy zachować minimalną odległość 5 cm, aby zapewnić dobrą wentylację.</p>	<p>26. Nie umieszczaj źródeł otwartego ognia, takich jak zapalone świece, w pobliżu urządzenia. 27. Urządzenie powinno być montowane na ścianie lub suficie tylko wtedy, gdy pozwala na to producent. 28. Ten produkt ma ostre narożniki. Należy obchodzić się z nim ostrożnie. 29. Nie wolno podejmować prób samodzielnej naprawy tego urządzenia. Otwarcie urządzenia może być niebezpieczne. Skontaktuj się z wykwalifikowanym specjalistą w sprawie wszelkich prac przy urządzeniu. 30. Gdy zachodzi potrzeba wymiany komponentów, należy stosować wyłącznie komponenty określone przez producenta lub komponenty o identycznych właściwościach technicznych jak w przypadku produktu oryginalnego. Użycie niezgodnych komponentów może spowodować pożar, porażenie prądem lub inne zagrożenia. 31. Po każdej obsłudze technicznej lub naprawie urządzenia trzeba je przetestować, aby sprawdzić, czy działa bezpiecznie. 32. Przed podłączeniem produktów i zwiększeniem głośności ustaw źródło na minimum. Gdy produkty są już na miejscu, stopniowo zwiększaj głośność do rozsądnego i komfortowego poziomu. 33. Aby uniknąć uszkodzenia słuchu, nie należy słuchać głośników przez dłuższy czas. Odsłuch przy dużej głośności może prowadzić do uszkodzenia uszu i problemów ze słuchem (chwilowa lub stała głuchota, brzęczenie w uszach, szумы uszne, nadwrażliwość na dźwięki). Narażenie uszu na głośność powyżej 85dB SPL-LAeq przez kilka godzin może nieodwracalnie uszkodzić słuch. 34. Po upływie produktu z opakowania przechowywane w miejscu niedostępnym dla dzieci. Może stwarzać ryzyko uduszenia. 35. Niektórzy użytkownicy nie mają wystarczającej autonomii, aby bezpiecznie korzystać z produktu samodzielnie. W szczególności dzieci poniżej 14 roku życia lub osoby z niektórymi rodzajami niepełnosprawności wymagają nadzoru i/lub towarzystwa podczas korzystania z urządzenia.</p>

	<div style="border: 1px solid black; padding: 5px; text-align: center;"> <p>CAUTION RISK OF ELECTRIC SHOCK DO NOT OPEN</p> </div>	
<p>Символ молнии внутри равностороннего треугольника предупреждает пользователя о том, что устройство находится под высоким напряжением и является источником опасности поражения электрическим током.</p>	<p>ПРЕДУПРЕЖДЕНИЕ: Во избежание поражения электрическим током не снимайте крышку (или заднюю панель) устройства. Внутри устройства отсутствуют детали, требующие обслуживания пользователем. Все работы по техническому обслуживанию и ремонт должны выполняться квалифицированным персоналом.</p>	<p>Символ предупреждения. В руководстве по эксплуатации этим символом обозначаются важные инструкции по безопасности, касающиеся погрузки и разгрузки, работы устройства и его технического обслуживания.</p>
<div style="display: flex; flex-direction: column;">                         </div> <ol style="list-style-type: none"> 1. Прочтите эти инструкции. 2. Сохраните эти инструкции. 3. Обращайте внимание на все предупреждения. 4. Выполняйте все инструкции. 5. Не используйте устройство вблизи воды. 6. Для чистки используйте только сухую ткань. 7. Не перекрывайте вентиляционные отверстия. При установке соблюдайте инструкции изготовителя. 8. Запрещается устанавливать устройство вблизи источников тепла, таких как батареи отопления, нагревательные приборы, кухонные плиты и другие устройства, выделяющие тепло (включая сушители). 9. Помните, что поляризованная вилка обеспечивает вашу безопасность. В поляризованной вилке есть два ножевых контакта, один из которых шире другого. Широкий ножевой контакт предназначен для обеспечения безопасности. Если поставляемая в комплекте вилка не входит в розетку, обратитесь к электрику для замены устаревшей розетки. 10. Берегите сетевой шнур, не наступайте на него и не допускайте его защемления, особенно в местах подключения к устройству или сети питания и на участках, прилегающих к сетевой вилке. 11. Используйте только те детали и аксессуары, которые были рекомендованы производителем. 12. Используйте только тележки, подставки, треноги, кронштейны и столы, которые были рекомендованы производителем или входили в комплект поставки устройства. Перевозка устройства на тележке, соблюдайте осторожность во избежание травм при опрокидывании. 13. Отключайте устройство от сети во время грозы или если оно не используется в течение продолжительного периода времени. 14. Все виды технического обслуживания должны проводить квалифицированные специалисты. Обслуживание требуется в случае любого повреждения устройства, например, если повреждены шнур питания или вилка, в устройстве пролилась жидкость или попал посторонний предмет, устройство находилось под дождем или во влажной среде, не работает должным образом или его уронили. 	<div style="display: flex; flex-direction: column;">                         </div> <ol style="list-style-type: none"> 15. Подключайте устройство к электросети того типа, который указан на корпусе устройства. Если вы не знаете, с какой электросетью совместимо устройство или электрооборудование, проконсультируйтесь с монтажником или электриком. См. информацию об устройствах, работающих от аккумуляторов и иных источников энергии, в руководстве по эксплуатации. 16. Ваше устройство относится к оборудованию класса I. Для подключения устройства к сети используйте только сетевую вилку с заземлением, включенную в комплект поставки. Сетевая розетка, к которой подключается устройство, также должна быть заземлена. 17. Если сетевая вилка или приборный соединитель используются в качестве устройства отключения, такое устройство отключения должно быть легкодоступно и в рабочем состоянии. Чтобы отключить оборудование от сети, извлеките вилку из розетки. 18. Не перегружайте штепсельные розетки, удлинители и розеточные блоки. Это может привести к возгоранию или поражению электрическим током. Не перегружайте компоненты установки сверх допустимой максимальной мощности. 19. ПРЕДУПРЕЖДЕНИЕ: Не подвергайте устройство воздействию воды и влажности и не оставляйте под дождем, чтобы снизить риски возгорания и поражения электрическим током. Защищайте устройство от брызг и капель жидкости и не ставьте на устройство наполненные жидкостью емкости, такие как вазы. 20. Запрещается вставлять посторонние предметы в вентиляционные отверстия устройства. Это может привести к контакту постороннего предмета и деталей под высоким напряжением или вызвать короткое замыкание, став причиной возгорания или поражения электрическим током. 21. Температура окружающей среды, в которой находится работающее устройство, не должна превышать 35°C. 22. Устройство не предназначено для использования в условиях тропического климата. 23. Не используйте устройство на высоте свыше 2000 м над уровнем моря (6500 футов). 24. Если при транспортировке устройства происходит перепад температур (от холодной к теплой), до подключения устройства к сети убедитесь в отсутствии конденсата. 	<div style="display: flex; flex-direction: column;">                         </div> <ol style="list-style-type: none"> 25. Для обеспечения надлежащей вентиляции обязательно оставляйте зазор не менее 5 см (2") по периметру устройства. 26. Не размещайте рядом с устройством источники открытого огня, такие как горящие свечи. 27. Настенный и потолочный монтаж допускается в том случае, если он разрешен производителем. 28. Обратите внимание на острые кромки устройства. Переносите устройство с осторожностью. 29. Не пытайтесь чинить устройство самостоятельно. Вскрывать устройство опасно. Все работы с устройством должны выполнять квалифицированные специалисты. 30. Для замены деталей устройства используйте только компоненты, рекомендованные производителем, или с идентичными характеристиками. Применение несоответствующих деталей может стать причиной возгорания и поражения электрическим током и связано с другими рисками. 31. Каждый раз после обслуживания или ремонта устройства проводите проверку безопасности его эксплуатации. 32. Установите уровень громкости источника звука на минимум и только потом подключите устройство и повысьте уровень громкости. После установки системы постепенно повышайте уровень громкости до разумного и приемлемого для вас уровня. 33. Во избежание повреждения органов слуха не используйте акустическую систему с установленным высоким уровнем громкости в течение длительного времени. Слишком высокий уровень громкости акустической системы может привести к повреждению органов слуха и вызвать различные его нарушения (временную или постоянную глухоту, шум в ушах, звон в ушах, гиперакузию). Воздействие на органы слуха звука громкостью более 85 дБ SPL - LAeq в течение нескольких часов может стать причиной необратимого нарушения слуха. 34. После распаковки устройства уберите упаковочный материал в недоступное для детей место. Упаковка представляет риск удушья. 35. Для некоторых пользователей самостоятельное использование устройства может быть небезопасным. В частности, дети младше 14 лет и люди с определенными типами инвалидности должны пользоваться устройством под присмотром/в присутствии других лиц.

	<div style="border: 1px solid black; padding: 5px; text-align: center;"> <p>CAUTION</p> <p>RISK OF ELECTRIC SHOCK DO NOT OPEN</p> </div>	
<p>带有等边三角形的闪电标志警告用户该设备具有高电压，可能导致触电危险。</p>	<p>警告：为避免触电危险，请勿从设备上卸下外壳（或后盖）。此设备中不包含用户可自行维修的部件。如需进行维护或修理，请联系有资质的专业人士。</p>	<p>警示标志。本符号旨在向用户警示用户手册中存在与设备搬运、操作和维护相关的重要说明。</p>
<div style="display: flex; flex-direction: column;"> <div style="margin-bottom: 10px;"></div> <div style="margin-bottom: 10px;"></div> <div style="margin-bottom: 10px;"></div> <div style="margin-bottom: 10px;"></div> <div style="margin-bottom: 10px;"></div> <div style="margin-bottom: 10px;"></div> <div style="margin-bottom: 10px;"></div> <div style="margin-bottom: 10px;"></div> <div style="margin-bottom: 10px;"></div> <div style="margin-bottom: 10px;"></div> <div style="margin-bottom: 10px;"></div> <div style="margin-bottom: 10px;"></div> <div style="margin-bottom: 10px;"></div> <div style="margin-bottom: 10px;"></div> <div style="margin-bottom: 10px;"></div> <div style="margin-bottom: 10px;"></div> <div style="margin-bottom: 10px;"></div> <div style="margin-bottom: 10px;"></div> <div style="margin-bottom: 10px;"></div> <div style="margin-bottom: 10px;"></div> <div style="margin-bottom: 10px;"></div> <div style="margin-bottom: 10px;"></div> <div style="margin-bottom: 10px;"></div> </div> <ol style="list-style-type: none"> 1. 请仔细阅读这些说明。 2. 请妥善保管这些说明。 3. 请注意所有警告。 4. 请谨慎遵循所有说明。 5. 请勿在水边使用本设备。 6. 仅可使用干布进行清洁。 7. 切勿阻塞任何通风口。请按照制造商的说明进行安装。 8. 请勿将其安装在任何热源附近，例如散热器、热风机、炉灶或其它发热设备（包括放大器）。 9. 切勿使极性插头（通用）的安全保护作用失效。极性插头有两个宽窄不同的插片。宽叶片的作用是保障安全。如果附带的插头与您的电源插座不匹配，请咨询电工以更换掉旧式的电源插头。 10. 请保护电源线免遭踩踏或挤压，尤其是在插头、插座以及从设备中引出的位置。 11. 仅使用制造商指定的附件/配件。 12. 只可使用制造商指定的、或者产品附带的推车、立架、三脚架、托架或台面。如果使用推车，当移动推车/设备整体时要注意避免其倾倒造成伤害。 13. 雷雨天气或长时间不使用时，请拔掉本设备的电源。 14. 所有的维修工作应由合格的维修人员执行。当设备出现任何损坏时，如电源线或插头损坏、液体洒入或物体落入设备、设备淋雨或受潮、运行不正常或跌落之后，需要进行维修保养。 15. 仅将本产品连接到设备上指示的电源类型。如果您不确定产品需要或您所安装的电源类型，请咨询安装人员或电力供应商。对于使用电池或其它类型电源的设备，请参见用户手册。 16. 本产品属于1类设备。仅使用随附的电源插头（带有接地线）连接设备。设备必须连接到带有接地的电源插座中。 17. 如果将电源插头或设备耦合器用作断开设备，该断开设备必须处于易接近、可操作状态。要使设备断开电源，请将电源插头从电源插座上拔下。 18. 请勿过载使用墙壁插座、延长线或多插口接线板。这会导致起火或触电。确保安装的每件设备不超出最大允许功率。 	<div style="display: flex; flex-direction: column;"> <div style="margin-bottom: 10px;"></div> <div style="margin-bottom: 10px;"></div> <div style="margin-bottom: 10px;"></div> <div style="margin-bottom: 10px;"></div> <div style="margin-bottom: 10px;"></div> <div style="margin-bottom: 10px;"></div> <div style="margin-bottom: 10px;"></div> <div style="margin-bottom: 10px;"></div> <div style="margin-bottom: 10px;"></div> <div style="margin-bottom: 10px;"></div> <div style="margin-bottom: 10px;"></div> <div style="margin-bottom: 10px;"></div> <div style="margin-bottom: 10px;"></div> <div style="margin-bottom: 10px;"></div> <div style="margin-bottom: 10px;"></div> <div style="margin-bottom: 10px;"></div> <div style="margin-bottom: 10px;"></div> <div style="margin-bottom: 10px;"></div> <div style="margin-bottom: 10px;"></div> <div style="margin-bottom: 10px;"></div> <div style="margin-bottom: 10px;"></div> <div style="margin-bottom: 10px;"></div> <div style="margin-bottom: 10px;"></div> <div style="margin-bottom: 10px;"></div> </div> <ol style="list-style-type: none"> 19. 警告：为减少火灾和触电危险，请勿使本设备接触水、雨水或湿气。此外，请勿使本设备处于滴水或溅水处，且不得在设备上方放置装有液体的物体（例如花瓶）。 20. 请勿将任何物体插入设备的通风孔。它们可能会接触高压组件，或导致短路并引起火灾或触电。 21. 使用本设备时，环境温度不应超过95华氏度（35摄氏度）。 22. 请勿在热带气候条件下使用本设备。 23. 请勿在海拔2,000米（6,500英尺）以上地区使用本设备。 24. 如果将产品从寒冷环境移动到温暖环境，请确保其未出现冷凝现象再连接电源线。 25. 始终在产品周围留出至少5厘米（2英寸）的空隙，以确保合理通风。 26. 设备附近请勿放置明火，例如燃烧的蜡烛等。 27. 本设备只可安装于制造商认可的墙壁或天花板。 28. 本产品带有尖锐边角。请小心握持。 29. 请勿尝试自行维修本设备。开启设备可能造成危险。请联系有资质的专业人士进行一切设备维护操作。 30. 当需要更换部件时，只可使用制造商指定的或与原产品技术规格相同的部件。使用不符合要求的部件可能导致火灾、触电或其他风险。 31. 对设备进行任何维护或修理工作时，请检查其是否安全可靠。 32. 请先将音量调至最小，然后再连接设备并调高音量。当产品安装就位，再逐渐将音量调高至合适的水平。 33. 为了避免损伤听力，请勿长时间在大音量下使用音箱。以大音量使用扬声器可对用户的耳朵造成损害，并可能导致听力问题（暂时或永久性耳聋、耳鸣、听力减退）。将耳朵暴露在高于85dB SPL LAeq的音量下数小时，可能会对听力造成不可逆的损害。 34. 将产品从包装中取出后，请将包装放在儿童接触不到的地方。产品包装可能引起窒息危险。 35. 部分行为能力不足的用户使用产品时可能存在危险。特别是14岁以下儿童以及患有部分残疾的人群，须在监管和/或陪同下使用本设备。 	

 <p>등변 삼각형 안의 번개 표시는 장치에 감전을 일으킬 수 있는 고전압이 흐른다는 것을 사용자에게 경고합니다.</p>	<div style="border: 1px solid black; padding: 5px; text-align: center;"> <p>CAUTION RISK OF ELECTRIC SHOCK DO NOT OPEN</p> </div> <p>경고: 감전 위험을 예방하기 위해, 장치로부터 커버(또는 뒷면)를 제거하지 마십시오. 이 장치에는 사용자가 정비할 수 있는 부품이 없습니다. 유지보수나 수리를 위해서는 유자격 전문가에게 문의하십시오.</p>	 <p>경고 기호. 이 기호는 사용 설명서에 언급되어 있으며, 기기의 취급, 자동, 유지관리와 관련된 중요한 지침이 있음을 경고합니다.</p>
 <p>1. 이 지침을 읽으십시오.</p>  <p>2. 이 지침을 보관하십시오.</p>  <p>3. 모든 경고에 주의하십시오.</p>  <p>4. 모든 지침을 준수하십시오.</p>  <p>5. 물 가까운 곳에서 이 장치를 사용하지 마십시오.</p>  <p>6. 청소시 마른 천만 사용하십시오.</p>  <p>7. 통풍구를 막지 마십시오. 제조자 지침에 따라 설치하십시오.</p>  <p>8. 라디에이터, 열 조절장치, 난로 또는 열을 발생시키는 기타 장치(앰프 포함)와 같은 열원 근처에 설치하지 마십시오.</p>  <p>9. 전극형 플러그의 안전 목적에 맞게 사용하십시오(일반). 극성 플러그에는 한 쪽이 다른 쪽보다 더 넓은 2개의 날이 있습니다. 넓은 날은 안전을 위한 것입니다. 제공된 플러그가 콘센트에 맞지 않으면 전기 기술자에게 연락하여 오래된 콘센트를 교체하십시오.</p>  <p>10. 전원 코드가 밟히거나 끼이지 않도록 보호하되, 특히 플러그, 콘센트, 그리고 장치에서 전원 코드가 빠져나오는 지점에 주의합니다.</p>  <p>11. 제조업체가 지정한 어태치먼트/액세서리만을 사용합니다.</p>  <p>12. 제조업체가 지정하거나 장치와 함께 판매되는 카트, 스탠드, 삼발이, 브래킷 또는 테이블만을 함께 사용하십시오. 카트를 사용하는 경우, 카트에 담은 장치를 움직일 때 튀어넘이지 않도록 주의하십시오.</p>  <p>13. 번개가 치고 있거나 장기간 사용하지 않는 동안에는 이 장치의 플러그를 뽑아두십시오.</p>  <p>14. 모든 정비는 유자격 정비사만이 실시할 수 있습니다. 장치가 어떤 방식(전원 코드나 플러그가 손상됨, 액체가 누출되거나 장치에 물체가 떨어짐, 장치가 비나 습기에 노출됨, 정상적으로 작동하지 않음, 장치를 떨어뜨림 등)으로든 손상된 경우, 정비가 필요합니다.</p>  <p>15. 이 제품을 기기에 표시되어 있는 전원 유형에만 연결하십시오. 제품 또는 전기 설비에 요구되는 전원 유형을 정확히 모르겠다면, 설치자 또는 전기 공급자에게 물어보십시오. 배터리를 기타 전원을 이용하여 사용하도록 되어 있는 장치의 경우는 사용자설명서를 참조하십시오.</p>	 <p>16. 이 제품은 Class 1 장비입니다. 접지 연결부가 있는 제공된 주전원 플러그를 이용하여 장치 전원을 연결하십시오. 이 장치는 접지된 주전원 소켓에 연결해야 합니다.</p>  <p>17. 전원 플러그 또는 장비 커플러를 단로 장치로 사용할 경우 단로 장치를 즉시 작동할 수 있는 상태로 유지해야 합니다. 기기를 전원에서 분리하려면 전원 콘센트에서 전원 플러그를 뽑으십시오.</p>  <p>18. 벽 콘센트, 연장 리드 또는 멀티 콘센트에 과부하를 주지 마십시오. 화재 또는 감전이 발생할 수 있습니다. 각 설비 구성요소의 최대 허용 전력을 초과하지 않도록 합니다.</p>  <p>19. 경고: 화재나 감전 위험을 줄이기 위해, 장치를 물, 비 또는 습기에 노출하지 마십시오. 또한 물이 떨어지거나 튀는 곳에 기기를 놓거나 꽃병 등 액체가 담긴 물건을 기기 위에 올려 놓으면 안 됩니다.</p>  <p>20. 장치의 통풍구에는 어떤 물체도 삽입해서는 안 됩니다. 이런 물체가 고압 구성품에 접촉하거나 단락시킴으로써 화재나 감전을 초래할 수 있습니다.</p>  <p>21. 기기를 사용할 때, 주변 온도는 35°C를 초과해서는 안 됩니다.</p>  <p>22. 이 장치를 열대성 기후에서 사용하면 안 됩니다.</p>  <p>23. 이 장치를 2,000m 이상의 고도에서 사용하지 마십시오.</p>  <p>24. 추운 환경에서 더운 환경으로 기기를 운반한 경우, 전원 케이블을 연결하기 전에 결로가 발생하지 않았는지 확인하십시오.</p>  <p>25. 통풍이 잘 이루어지도록 제품 주변에는 최소 5cm의 여유를 두십시오.</p>  <p>26. 기기 근처에 터는 촛불 등의 노출된 화원을 두지 마십시오.</p>  <p>27. 장비를 벽 또는 천장(제조사에서 허용한 경우)에만 장착해야 합니다.</p>  <p>28. 이 제품에는 날카로운 모서리가 있습니다. 주의해서 취급하십시오.</p>  <p>29. 이 장치를 직접 수리하지 마십시오. 기기를 여는 것은 위험할 수 있습니다. 기기에 대한 모든 작업은 유자격 전문가에게 문의하십시오.</p>  <p>30. 교체 구성품이 필요한 경우 제조사가 지정한 구성품 또는 원래 제품과 동일한 기술적 특징을 지닌 구성품만을 사용하십시오.</p>	 <p>비규격 구성품을 이용할 경우 화재, 감전 또는 기타 위험이 발생할 수 있습니다.</p>  <p>31. 장치에 대해 유지관리 또는 수리 작업을 수행한 후에는, 제품을 안전하게 작동하는지 검사하십시오.</p>  <p>32. 음원의 음량을 최소로 두고 나서 제품을 연결하고 음량을 올리십시오. 제품 수명이 끝나고 후에 적당하고 듣기 편안한 정도까지 음량을 서서히 올립니다.</p>  <p>33. 청력 손상을 피하기 위해 장시간 높은 음량으로 라우드스피커를 듣지 마십시오. 과도한 음량으로 라우드스피커의 소리를 들을 경우 사용자의 청력을 손상하여 청력 문제(일시적 멍멍함, 귀속이 울림, 이명, 청각과민)를 야기할 수 있습니다. 여러 시간 동안 85dB SPL - LAeq보다 높은 음량에 귀를 노출할 경우 회복 불가능한 청력 손상이 올 수 있습니다.</p>  <p>34. 포장에서 제품을 꺼낸 후에는, 포장을 어린이의 손이 닿지 않는 곳에 두십시오. 어린이가 가지고 놀 경우 질식 위험이 있습니다.</p>  <p>35. 일부 사용자는 스스로는 위험 없이 제품을 사용할 충분한 능력이 없을 수 있습니다. 특히 14세 미만의 어린이 또는 특정 유형의 장애를 가진 사람은 기기 사용자 감독을 받거나 보호자의 동반이 필요합니다.</p>

	<div style="text-align: center; border: 1px solid black; padding: 5px;"> CAUTION RISK OF ELECTRIC SHOCK DO NOT OPEN </div>	
<p>正三角形の中の矢印記号が付いた稲妻マークは、人が感電するリスクとなるような「危険な」電圧が製品内部に存在することをユーザーに対して注意喚起する目的があります。</p>	<p>警告：感電の危険を防ぐため、装置からカバー（または背面）を取り外さないでください。専門家のみが修理できる装置です。メンテナンスまたは修理については、有資格者にお問い合わせください。</p>	<p>"正三角形で示されている感嘆符（！）は、装置の使用とメンテナンスに関するユーザーマニュアルに重要な指示があることをユーザーに警告するものです。"</p>
<p>1. 説明書を読んでください。 2. 説明書を保管してください。 3. すべての警告に注意してください。 4. すべての指示に従ってください。 5. 水の近くで使用しないでください 6. 乾燥した布でのみ清掃してください。 7. 換気口をふさがないでください。メーカーの指示に従い、機器を設置してください。 8. 暖房器、レンジ、暖房の温風口または熱を発するその他のあらゆる機器（アンプも含めた）など、熱源のそばに機器を設置しないでください。 9. 有極プラグは安全のために用いられていますので、正しく使用してください。有極プラグには2つのプレートがあり、一方は他方より幅が広いです。幅の広い方のプレートは、安全を確保するために備わっています。付属のプラグがコンセントの差し込み口に合わない場合は、電気工事業者者に相談し、古いコンセントを新しいものと交換してください。 10. 電源ケーブルにねじれ、つぶれ、引っ掛かりがないか確認してください。電気プラグや機器のコード接続に、細心の注意を払ってください。 11. メーカーが推奨する付属品のみを使用してください。 12. メーカーが推奨する、または機器とともに販売される運搬機械、レッグ、三脚、スタンド、台のみ使用してください。台車を使用する際は、転倒によるケガを回避するために、台車と機器全体の移動中、さらなる配慮を心がけてください。 13. 雷雨のときや長期間使用しないときは、プラグを抜いてください。 14. メンテナンス作業はすべて、資格を有する技術者により実施されなければなりません。ケーブルまたは電気プラグの破損、液体の浸潤または機器内への異物混入、雨または湿気への露出、機器の機能不順または倒壊など、機器に損害が起きた際はメンテナンスが必要です。 15. 機器をラベルに表示されている主電源のみに接続してください。使用している主電源の種類がわからない場合は、小売業者または電力会社にお問い合わせください。バッテリーまたは他の電源を使用する機器については、ユーザーマニュアルを参照してください。 16. この製品は分類1にあたります。機器の接続には、アース線が内蔵された付属の電気プラグのみを使用してください。必ずアース接続で保護された電気コンセントに機器を繋いでください。</p>	<p>17. 機器の主電源プラグまたはソケットを切断装置として使用する場合は、この機器にすぐに手が届くようにしておく必要があります。 18. 壁のコンセント、延長コード、あるいはマルチタップに負担をかけ過ぎないようにしてください。火災や感電を引き起こす可能性があります。設置システムの各機器に許容された最大出力を守ってください。 19. 警告：火災や感電を防ぐために、本装置を雨や湿気にさらさないでください。また、装置を水滴や水しぶきにさらさず、花瓶などの液体で満たされた物を装置の上に置かないでください。 20. 装置の換気口に物を挿入しないでください。高電圧コンポーネントのものと接触したり、ショートしたりして、火災や感電を引き起こす可能性があります。 21. 装置は、35度以下の場所でお使いください。 22. 熱帯気候下でこの機器を使用しないでください。 23. 標高2000m以上で使わないでください。 24. 機器を寒い場所から暖かい場所に急に持ち込むと結露が発生する可能性があります。そのため、その場合に結露が消えてから電源を入れてください。 25. 適切に換気をするために、装置を他の物体から少なくとも5cm離してください。 26. 装置の上にはろうそくなどの裸火を置かないでください。 27. メーカーからの指示がない限り、装置を壁や天井に取り付けしないでください。 28. この製品には角は尖っている部分があります。取り扱いには注意してください。 29. ご自分で修理をしないようにしてください。危険な電圧やその他の危険が発生する可能性があります。全ての修理は有資格者にお問い合わせください。 30. コンポーネントの交換が必要な場合は、メーカーが指定したものの、または元のコンポーネントと同等の特性を持つものを使用してください。適合しない部品は、火災や感電、その他のリスクを引き起こす可能性があります。 31. 本製品に対して作業や修理を行った後は、製品が安全に動作することを確認するためのテストを実施してください。</p>	<p>32. 接続機器のポリウムを最小にしてから、本製品を接続しポリウムを上げてください。製品の設定が終了した後、ポリウムを徐々に上げて、適切で快適な音量になるように調整してください 33. 聴力に影響を与える恐れがありますので、大音量で長時間続けて聞きすぎないでください。大音量でスピーカーを聞くと、ユーザーの耳に損傷を与え、聴覚障害（一時的または永続的な難聴、耳鳴り、耳鳴り、聴覚過敏）を引き起こす可能性があります。過度の音量（85dB以上）を1時間以上聞き続けると、回復が不可能なほど聴力を損なう可能性があります。 34. 製品をパッケージから取り出した後、お客様の手の届くところにパッケージを放置しないでください。室温のリスクがあります。 35. 使用者の中には、自分自身で安全に製品を使用するための十分な自立性がない場合があります。特に、14歳未満のお子様および特定の障害をお持ちの方が機器を使用する場合は、監視および/または同伴が必要ですよ。"</p>

	<div style="text-align: center; border: 1px solid black; padding: 5px; background-color: #f0f0f0;"> CAUTION RISK OF ELECTRIC SHOCK DO NOT OPEN </div>	
<p>等腰三角形中的閃電符號是用來警告使用者裝置具有高電壓，可能導致觸電風險。</p>	<p>警告：為了避免觸電風險，請勿將裝置的封蓋（或背殼）移除。此裝置中沒有使用者可自行更換的零件。請聯繫合格專業人員進行維護或維修。</p>	<p>等腰三角形中的驚嘆號用以警示使用者，注意手冊中含有關於使用和照顧裝置的重要說明。</p>
 1. 請詳閱以下指示。  2. 請妥善保存說明書。  3. 請留意所有的警告事項。  4. 請遵守所有的指示。  5. 請勿在靠近水的地方使用本裝置。  6. 僅能使用乾布擦拭清潔。  7. 請勿阻塞風扇口。請遵守製造商指示安裝本裝置。  8. 請勿將本裝置安裝於靠近熱源處，例如暖氣散熱片、爐灶、暖氣口或任何其他會散發熱氣的裝置（包括擴大機）。  9. 請務必使用極化插頭。一個極化插頭上會有兩片刀片，其中一片比較大，大的刀片是用於保護您的安全。若隨附的插頭無法插入您的插座，請找水電技師為您更換舊插座。  10. 請確認電源線不會遭到踩踏、壓迫或夾擠。請特別注意電源插頭及連接到裝置上的電源線。  11. 僅能使用製造商建議的配件。  12. 僅能使用製造商建議或隨裝置一同出售的裝運箱、支架、腳架、支撐設備或檯面。使用裝運箱時，請在同時移動裝運箱與裝置的期間加倍謹慎，避免因搖晃導致受傷。  13. 在暴雨或長時間不使用裝置的情況下，請拔除裝置電源。  14. 所有的維修工作皆必須由具專業資格人員執行。裝置一旦遭到任何損傷，就必須進行維修，例如電源線或電源插頭損壞、液體滲入或物件掉入裝置內、被雨水淋濕或暴露在潮濕環境中、運作不良或無法運作  15. 僅能將本產品連接至裝置上標示的市電種類。若您對產品所需的電力種類、或對您的電力設備有疑問，請諮詢產品銷售商或電力供應商。針對靠電池或其他電力來源運作的裝置，請參閱使用說明書。  16. 本產品屬於第一類裝置。僅能使用隨附的插頭（內含接地線）連接本裝置。必須使用配備有接地保護的插座連接本裝置。  17. 當接上電力網路時，無論是接上插座或 使用 On/Off 開關切換供電，本裝置應位於可輕易取得之處。	 18. 請勿使牆壁插座、延長線或多孔插座電力超載。這可能引發火災或觸電。  19. 注意：為減少火災或觸電的風險，請勿讓裝置暴露在接觸水分、雨水或濕氣的環境下。此外，裝置不得置於有滴水或水濺出之處，亦不得將任何裝水的容器（例如花瓶）放在裝置上。  20. 絕對不可透過風扇孔，塞入任何物件。物件可能會接觸到產生高壓電或短路的零件，而引發火災或觸電。絕對不要把液體灑灑在裝置上。  21. 使用本裝置時，室溫不應超過攝氏35度（華氏95度）。  22. 請勿在熱帶氣候下，使用本裝置。  23. 請勿在高度超過2000公尺的區域，使用本裝置  24. 若將本裝置從寒冷處移至暖熱的環境中，請在插上電源前，先確認沒有發生任何水氣凝結現象。  25. 請在產品周圍保留至少5公分（2吋）的空間，以確保風扇可良好運作。  26. 請勿在裝置上擺放任何明火火源，例如點燃的蠟燭。  27. 本裝置將不得安裝在牆上或天花板上，除非出自建築師的安排設計。  28. 本產品存在尖角。請小心拿取。  29. 請勿試圖自行修復裝置。拆開此裝置可能導致您接觸到危險的電壓、或產生其他風險。如需進行任何維修，請聯繫具專業資格之人員。  30. 如需替換零件，請確保維修技師使用製造商指定的零件，或與原件規格相同的零件。使用規格不一致的零件，可能導致火災、觸電或其他風險。  31. 在對裝置進行任何處理或維修之後，請要求維修技師進行測試，以確保產品可安全運作。  32. 在連接產品和提高音量之前，請將信號源的音量調到最小。產品就位後，逐漸將音量提高到合理且舒適的水準。  33. 為避免損傷聽力，請勿長時間以高音量聆聽。使用過高的音量聆聽可能損害使用者的耳朵，造成聽覺問題暫時性或永久性的重聽、耳鳴、聽覺過敏）。暴露在均能音量聲壓級（SPL LAeq）高於85分貝的環境下數小時，可能造成不可逆的聽覺損害。  34. 將產品拆封後，請確保將包裝材料放置於兒童無法取得處。因為其可能造成窒息風險。  35. 某些用戶不具備足夠的自主權，無法單獨安全使用產品。特別注意，14歲以下的兒童和有些殘障人士在使用該產品時必須有人監督和陪同。	 33. 為避免損傷聽力，請勿長時間以高音量聆聽。使用過高的音量聆聽可能損害使用者的耳朵，造成聽覺問題暫時性或永久性的重聽、耳鳴、聽覺過敏）。暴露在均能音量聲壓級（SPL LAeq）高於85分貝的環境下數小時，可能造成不可逆的聽覺損害。  34. 將產品拆封後，請確保將包裝材料放置於兒童無法取得處。因為其可能造成窒息風險。  35. 某些用戶不具備足夠的自主權，無法單獨安全使用產品。特別注意，14歲以下的兒童和有些殘障人士在使用該產品時必須有人監督和陪同。

 <p>تحذير: صاعقة البرق في المثلث متساوي الأضلاع المستخدم من أن الجهاز يعمل بجهد مرتفع قد يتسبب في خطر حدوث صدمة كهربائية.</p>	<div style="border: 1px solid black; padding: 5px; text-align: center;"> CAUTION RISK OF ELECTRIC SHOCK DO NOT OPEN </div> <p>تحذير: لمنع أي خطر للصدمة الكهربائية، تجنب إزالة الغطاء (أو الجزء الخلفي) من الجهاز. لا يتضمن هذا الجهاز أي أجزاء يمكن للمستخدم صيانتها بنفسه. لإجراء أعمال الصيانة أو الإصلاح، اتصل بمهني مؤهل.</p>	 <p>رمز التحذير. هذا الرمز مصمم لتنبيه المستخدم إلى وجود تعليمات مهمة متذكورة في دليل المستخدم وتعلق بالتعامل مع الجهاز وتشغيله وصيانتها.</p>
<p>30. عندما تقتضي الضرورة الحصول على مكونات بديلة، استخدم فقط المكونات التي تحددها الشركة المصنعة أو المكونات ذات السمات الفنية المطابقة لتلك الخاصة بالمنتج الأصلي. حث يؤدي استخدام مكونات غير متوافقة إلى نشوب حرائق أو حدوث صدمات كهربائية أو مخاطر أخرى.</p> <p>31. بعد إجراء أعمال الصيانة أو الإصلاح على الجهاز، اختبره للتحقق من عمله بشكل آمن.</p> <p>32. اضبط المصدر على الحد الأدنى قبل توصيل المنتجات وزيادة مستوى الصوت. وبعد توصيل جميع المنتجات، قم بزيادة مستوى الصوت تدريجياً إلى مستوى مناسب ومريح.</p> <p>33. لتجنب الإضرار بسمعك، تجنب الاستماع إلى مكبرات الصوت بمستويات صوت عالية لفترات طويلة. فقد يؤدي الاستماع الياه بمستويات صوت زائدة إلى الإضرار بأباني المستخدم وقد يسبب ذلك مشكلات في السمع (الصمم المؤقت أو الدائم، طنين الأذنين، احتداد السمع). ويؤدي تعرض أذنك لمستوى صوت يتجاوز 85 ديسيبل (SPL-LAeq) لعدة ساعات إلى الإضرار الدائم بسمعك.</p> <p>34. بعد إخراج المنتج من عبوته، احتفظ بالعبوة بعيداً عن متناول الأطفال. فقد تطوي على خطر الاختناق.</p> <p>35. هناك بعض المستخدمين الذين لا يتمتعون بالاستقلالية الكافية التي تزدهم لاستخدام المنتج بمفردهم دون أن يتعرضوا للخطر. ويجب على وجه الخصوص الإشراف على الأطفال دون سن 14 عاماً أو المصابين ببعض أنواع الإعاقات و/أو إصحابهم عند استخدام الجهاز.</p>	<p>17. عند استخدام القابس الرئيسي أو وصلة الجهاز كجهاز فصل، يجب أن يظل جهاز الفصل قابلاً للتشغيل بسهولة. لفصل الجهاز عن مصدر التيار الكهربائي الرئيسي، قم ب إزالة القابس من مأخذ التيار الكهربائي الرئيسي.</p> <p>18. تجنب التحميل الزائد على مقابس الجدار أو الوصلات السلكية أو مأخذ التيار متعددة المقابس. فقد يؤدي هذا إلى نشوب حريق أو حدوث صدمة كهربائية. احرص على عدم تجاوز الحد الأقصى المسموح به لفترة كل مكون بالتركيب الكهربائي.</p> <p>19. WARNING: لتقليل مخاطر نشوب حريق أو حدوث صدمة كهربائية، تجنب تعريض هذا الجهاز للماء أو الأمطار أو الرطوبة. وبالإضافة إلى ذلك، يجب عدم تعريض الجهاز لقطرات أو رذاذ السوائل وعدم وضع أي أشياء مملوءة بالسوائل، مثل المزهريات، على الجهاز.</p> <p>20. يجب عدم إدخال أي أجسام في فتحات تهوية الجهاز؛ فقد تتلامس مع مكون من مكونات الفولتية العالية أو تُحدث بها قصوراً في الدائرة وتنتسب في نشوب حريق أو صدمة كهربائية. ويجب عدم سكب سائل (مثل القهوة) على الجهاز.</p> <p>21. عند استخدام الجهاز، لا يجب أن تتجاوز درجة الحرارة المحيطة 95 درجة فهرنهايت (35 درجة سيليزوس).</p> <p>22. لا تستخدم هذا الجهاز في مناطق المناخ الاستوائي.</p> <p>23. ممنوع استخدام هذا الجهاز على ارتفاعات تتجاوز 2000 متر.</p> <p>24. إذا تم نقل الجهاز من بيئة باردة إلى أخرى دافئة، فتأكد من عدم تراكم أي تكثف بداخله قبل توصيله بكل التيار الكهربائي.</p> <p>25. يجب دائماً ترك مسافة قدرها 5 سم (بوصة) على الأقل حول الجهاز من أجل التهوية السليمة.</p> <p>26. تجنب وضع مصادر اللهب المكتشفة، مثل الشموع المضادة، بالقرب من الجهاز.</p> <p>27. يجب تركيب الجهاز فقط على جدار أو في السقف إذا كانت الشركة المصنعة تجيز ذلك.</p> <p>28. هذا المنتج له زوايا حادة. فتعامل معه بحذر.</p> <p>29. لا تحاول إصلاح هذا الجهاز بنفسك. فقد يكون فتح الجهاز محفوفاً بالمخاطر. اتصل بمهني مؤهل لإجراء جميع الأعمال على الجهاز.</p>	<p>1. اقرأ هذه التعليمات.</p> <p>2. احتفظ بهذه التعليمات.</p> <p>3. انتبه لجميع التحذيرات.</p> <p>4. اتبع جميع التعليمات.</p> <p>5. لا تستخدم هذا الجهاز بالقرب من الماء.</p> <p>6. نظفه فقط بقطعة قماش جافة.</p> <p>7. لا تدمد أي فتحات تهوية.</p> <p>8. لا تتركب الجهاز بالقرب من أي مصادر للحرارة، مثل المبردات أو فتحات التدفئة أو المواد والأجهزة الأخرى (وتشمل المضخات) التي تنتج الحرارة.</p> <p>9. لا تلغى إعداد السلامة للقابس المستقطب (العام). يضم القابس المستقطب شفتين (إحدهما معرض من الأخرى). تتوفر الشفرة العريضة لسلاطك. إذا لم يلائم القابس المتوفر مأخذ التيار الكهربائي لديك، فاستعن بكهربائي لاستبدال مأخذ التيار القديم.</p> <p>10. وفر الحماية لمسك التيار الكهربائي بحيث لا يتم السير فوقه أو حشره لا سيما في مواضع القوابس ومآخذ التيار الكهربائي ومواضع خروجها من الجهاز.</p> <p>11. استخدم فقط الملحقات/المرفقات التي تحددها الشركة المصنعة.</p> <p>12. استخدم الجهاز فقط مع العربة أو الحامل أو الحامل ثلاثي القوائم أو السناد أو الطاولة التي تحددها الشركة المصنعة، أو تباع مع الجهاز. عند استخدام العربة توخ الحرس عند نقل مجموعة العربة/الجهاز لتجنب انقلابها وحدث إصابة من جراء ذلك.</p> <p>13. أفضل هذا الجهاز عن مصدر التيار الكهربائي أثناء العواصف الرعدية أو أثناء عدم استخدامه لفترات طويلة.</p> <p>14. قم بإبادة جميع أعمال الصيانة إلى فريق صيانة مؤهل. الصيانة المطلوبة عند تلف الجهاز بأية طريقة، مثل تلف مسك التيار الكهربائي أو القابس، أو انسكاب أي سائل أو سقوط أي أشياء على الجهاز، أو تعرض الجهاز للأمطار أو الرطوبة، أو عدم تشغيله بشكل طبيعي أو سقوطه.</p> <p>15. وصل هذا المنتج فقط بنوع مصدر التيار الكهربائي المبين على الجهاز. إذا لم تكن متأكدًا بشأن نوع مصدر التيار الكهربائي المطلوب للمنتج أو التركيبات الكهربائية لديك، فاستشر الشخص القائم بالتركيب أو شركة الكهرباء. بالنسبة للأجهزة المصممة للتشغيل بواسطة بطارية أو مصدر تيار كهربائي آخر، راجع دليل المستخدم.</p> <p>16. هذا المنتج من الفئة Class 1. وصل الجهاز فقط باستخدام قابس التيار الكهربائي المتوفر، والذي يتضمن وصلة تأريض. يجب توصيل الجهاز بمقبس تيار كهربائي مؤرض.</p>

REGISTER YOUR PRODUCT ONLINE



[www.focal.com/
warranty](http://www.focal.com/warranty)

- FR** Enregistrer votre produit en ligne
- DE** Registrieren Sie Ihr Produkt online
- ES** Registre su producto en línea
- IT** Registra il tuo prodotto online
- PT** Possível registar um produto online
- NL** Registreer uw product online
- PL** Zarejestruj swój produkt online
- RU** Зарегистрируйте свой продукт онлайн
- ZH** 您可以在线注册产品
- KO** 당신의 제품을 온라인에서 등록하세요
- JP** 製品のオンライン登録をお願いします
- AR** يمكنك الآن تسجيل منتجك عبر الإنترنت



PAP

Raccolta differenziata.
Verifica le disposizioni
del tuo Comune.



FR



ET



CALES



BAC
DE TRI

Cet appareil
se recycle

REPRISE
A LA LIVRAISON



OU

A DÉPOSER
EN MAGASIN



OU

A DÉPOSER
EN DÉCHÈTERIE



Points de collecte sur www.quefairemesdechets.fr

Scansionare il codice QR per
informazioni sullo smaltimento
degli imballaggi
Scan QR code for information
on packaging disposal